



RA-Series

USER'S GUIDE

www.planar.com

Planar utilizes HDMI ® standards in this product.

The terms HDMI, HDMI High-Definition Multimedia Interface, HDMI Trade dress and the HDMI Logos are trademarks or registered trademarks of HDMI Licensing Administrator, Inc.

Safety Instructions

Safety precautions and maintenance



WARNING: Use of controls, adjustments or procedures other than those specified in this documentation may result in exposure to shock, electrical hazards and/or mechanical hazards.

Read and follow these instructions when connecting and using your display:

Operation:

- Keep the display out of direct sunlight and away from stoves or any other heat sources.
- Remove any object that could fall into ventilation holes or prevent proper cooling of the display's electronics.
- Do not block the ventilation holes on the cabinet.
- When positioning the display, make sure the power plug and outlet are easily accessible.
- When turning off the display by detaching the power cord, wait 6 seconds before re-attaching the power cord for normal operation.
- Ensure the use of an approved power cord provided by Planar at all times.
- Do not subject the display to severe vibration or high impact conditions during operation.
- Do not knock or drop the display during operation or transportation.

Maintenance:

- To protect your display from possible damage, do not put excessive pressure on the LCD panel. When moving the display, grasp the handles on the rear of the display to lift. Do not lift the display by placing your hands on the LCD panel or bezel.
- Unplug the display if you are not going to use it for an extensive period of time.
- When the surface of the display becomes dirty, wipe the surface lightly with a soft clean cloth. If the surface requires additional cleaning, use LCD screen cleaner or LCD wipes, which are available at most electronics stores. Do not let cleaner seep into the display, as it may cause electrical shock or damage.
- To avoid the risk of shock or permanent damage to the set, do not expose the display to dust, rain, water or an excessively moist environment.
- If your display becomes wet, wipe it with dry cloth as soon as possible.
- If a foreign substance or water gets in your display, turn the power off immediately and disconnect the power cord. Then remove the foreign substance or water, and send the unit to the maintenance center.
- Do not store or use the display in locations exposed to heat, direct sunlight or extreme cold.
- In order to maintain the best performance of your display and ensure a longer lifetime, we strongly recommend using the display in a location that falls within the following temperature and humidity ranges.
 - Temperature: 0-40°C 32-104°F
 - Humidity: 20-80% RH

IMPORTANT: Always activate a moving screen saver program when you leave your display unattended. Always activate a periodic screen refresh application if the unit will display unchanging static content. Uninterrupted display of still or static images over an extended period may cause "burn in", also known as "after-imaging" or "ghost imaging", on your screen. This is a well-known phenomenon in LCD panel technology. In most cases, the "burned in" or "after-imaging" or "ghost imaging" will disappear gradually over a period of time after the power has been switched off.

WARNING: Severe "burn-in" or "after-image" or "ghost image" symptoms will not disappear and cannot be repaired. This is also not covered under the terms of your warranty.

Service:

- The casing cover should be opened only by qualified service personnel.
- If there is any need for repair or integration, please contact Planar Technical Support.
- Do not leave your display under direct sunlight.

CE Declaration of Conformity

We declare under our responsibility that the product is in conformity with the following standards:

- EN60950-1:2006+A11:2009+A1:2010+A12:2011+A2:2013 (Safety requirement of Information Technology Equipment).
- EN55022:2010 (Radio Disturbance requirement of Information Technology Equipment).
- EN55024:2010 (Immunity requirement of Information Technology Equipment).
- EN61000-3-2:2006 +A1:2009+A2:2009 (Limits for Harmonic Current Emission).
- EN61000-3-3:2008 (Limitation of Voltage Fluctuation and Flicker)
- EN 50581:2012 (Technical documentation for the assessment of electrical and electronic products with respect to the restriction of hazardous substances)
- EN 50564:2011 (Electrical and electronic household and office equipment — Measurement of low power consumption)

following provisions of directives applicable.

- 2006/95/EC (Low Voltage Directive).
- 2004/108/EC (EMC Directive).
- 2009/125/EC (ErP, Energy-related Product Directive, EC No. 1275/2008 and 642/2009 Implementing)
- 2011/65/EU (RoHS Directive) and is produced by a manufacturing organization on ISO9000 level.

Federal Communications Commission (FCC) Notice (U.S. Only)



This equipment has been tested and found to comply with the limits for a Class B digital device, pursuant to part 15 of the FCC Rules. These limits are designed to provide reasonable protection against harmful interference in a residential installation. This equipment generates, uses and can radiate radio frequency energy and, if not installed and used in accordance with the instructions, may cause harmful interference to radio communications. However, there is no guarantee that interference will not occur in a particular installation. If this equipment does cause harmful interference to radio or television reception, which can be determined by turning the equipment off and on, the user is encouraged to try to correct the interference by one or more of the following measures:

- Reorient or relocate the receiving antenna.
- Increase the separation between the equipment and receiver.
- Connect the equipment into an outlet on a circuit different from that to which the receiver is connected.



Changes or modifications not expressly approved by the party responsible for compliance could void the user's authority to operate the equipment.

Use only an RF shielded cable that was supplied with the display when connecting this display to a computer device.

To prevent damage which may result in fire or shock hazard, do not expose this appliance to rain or excessive moisture.

THIS CLASS B DIGITAL APPARATUS MEETS ALL REQUIREMENTS OF THE CANADIAN INTERFERENCE- CAUSING EQUIPMENT REGULATIONS.



This device complies with Part 15 of the FCC Rules. Operation is subject to the following two conditions: (1) this device may not cause harmful interference, and (2) this device must accept any interference received, including interference that may cause undesired operation.

End-of-Life Disposal

Your new Public Information Display contains materials that can be recycled and reused. Specialized companies can recycle your product to increase the amount of reusable materials and to minimize the amount to be disposed of.

Please find out about the local regulations on how to dispose of your old display from your local dealer.

(For customers in Canada and U.S.A.)

This product may contain lead and/or mercury. Dispose of in accordance to local-state and federal regulations. For additional information on recycling contact www.eia.org (Consumer Education Initiative)

Waste Electrical and Electronic Equipment-WEEE

Attention users in European Union private households



This marking on the product or on its packaging illustrates that, under European Directive 2012/19/EU governing used electrical and electronic appliances, this product may not be disposed of with normal household waste. You are responsible for disposal of this equipment through a designated waste electrical and electronic equipment collection. To determine the locations for dropping off such waste electrical and electronic, contact your local government office, the waste disposal organization that serves your household or the store at which you purchased the product.

Attention users in United States:

Please dispose of according to all Local, State and Federal Laws. For the disposal or recycling information, contact: www.mygreenelectronics.com or www.eiae.org.

End of Life Directives-Recycling



Your new Public Information Display contains several materials that can be recycled for new users.

Please dispose of according to all Local, State, and Federal laws.

Table Of Contents

1. Unpacking and Installation	1	6. Input Mode	20
1.1. Unpacking.....	1	7. Troubleshooting	21
1.2. Package Contents.....	1	8. Technical Specifications	22
1.3. Installation Notes.....	1	8.1. RA4980.....	22
1.4. IR remote sensor and power status indicator.....	2	8.2. RA5580.....	24
1.5. Mounting on a Wall.....	3		
1.5.1. VESA Grid.....	3		
1.6. Mounting in Portrait Position.....	4		
2. Parts and Functions	5		
2.1. Control Panel.....	5		
2.2. Input/Output Terminals.....	6		
2.3. Remote Control.....	7		
2.3.1. General functions.....	7		
2.3.2. ID Remote Control.....	8		
2.3.3. Inserting the batteries in the remote control.....	9		
2.3.4. Handling the remote control.....	9		
3. Connecting External Equipment	10		
3.1. Connecting Multiple Displays in a Daisy-chain Configuration.....	10		
3.1.1. Display control connection.....	10		
3.1.2. Digital video connection.....	10		
3.1.3. Analog video connection.....	11		
3.2. Connecting Audio Equipment.....	12		
3.2.1. Connecting external speakers.....	12		
3.2.2. Connecting an external audio device.....	12		
3.3. IR connection.....	13		
3.4. IR Pass-through Connection.....	13		
4. Operation	14		
4.1. Watch the Connected Video Source.....	14		
4.2. Change Aspect Ratio.....	14		
4.3. Choose your Preferred Picture Settings.....	14		
4.4. Choose your Preferred Sound Settings.....	14		
4.5. Installing OPS Modules.....	14		
5. Change your settings	14		
5.1. Settings.....	15		
5.1.1. Picture.....	15		
5.1.2. Sound.....	16		
5.1.3. Tiling.....	16		
5.1.4. General settings.....	17		
5.2. Network Settings.....	19		

1. Unpacking and Installation

1.1. Unpacking

- This product is packed in a carton, together with the standard accessories.
- Any other optional accessories will be packed separately.
- Due to the size and weight of this display it is recommended for two people to move it.
- After opening the carton, ensure that the contents are complete and in good condition.

1.2. Package Contents

Please verify that you received the following items with your package content:

- LCD display
- Remote control with AAA batteries
- Power cord (1.8 m)
- RS232 cable (1.8 m)
- DP cable (1.8m)
- IR extender cable (1.5m)
- IR loop cable (1.8m)
- RS232 loop cable (1.8m)
- Alignment plate: 3 pieces
- Washer: 4 pieces
- Screw: 4 pieces
- Spacer: 6 pieces
- Quick Start Guide

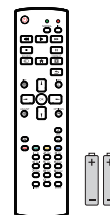

Remote Control
and AAA Batteries



Power Cord



DP Cable



Alignment Plate (3)

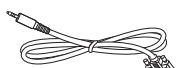

RS232 Cable

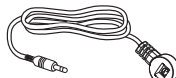

IR Extender Cable



Spacer (6) Washer (4) Screw (4)

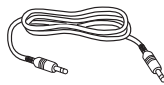

IR Loop Cable



RS232 Loop Cable



Quick Start Guide

NOTES:

- For all other regions, apply a power cord that conforms to the AC voltage of the power socket and has been approved by and complies with the safety regulations of the particular country.
- You might like to save the package box and packing material for shipping the display.

1.3. Installation Notes

- Due to high power consumption, always use the plug exclusively designed for this product.
- The product should be installed on a flat surface to avoid tipping. The distance between the back of the product and the wall should be maintained for proper ventilation. Avoid installing the product in the kitchen, bathroom or any other places with high humidity so as not to shorten the service life of the electronic components.
- The product can normally operate only under 3000m in altitude. In installations at altitudes above 3000m, some abnormalities may be experienced.

1.4. IR remote sensor and power status indicator

1. For optimal IR remote control performance, pull down the retractable lens from the backside of the display. The LED power status light is also best viewed when the lens is pulled down.
2. When tiled in video walls, the lens should be pushed up to optimize tiling.
3. You will hear a click when the lens is fully in position.

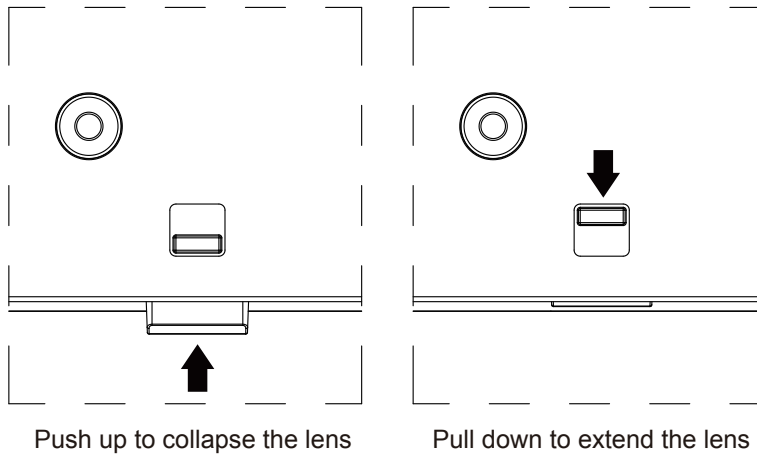

1.5. Mounting on a Wall

To mount this display to a wall, you will have to obtain a standard wall-mounting kit (commercially available). We recommend using a mounting interface that complies with TUV-GS and/or UL1678 standard in North America.

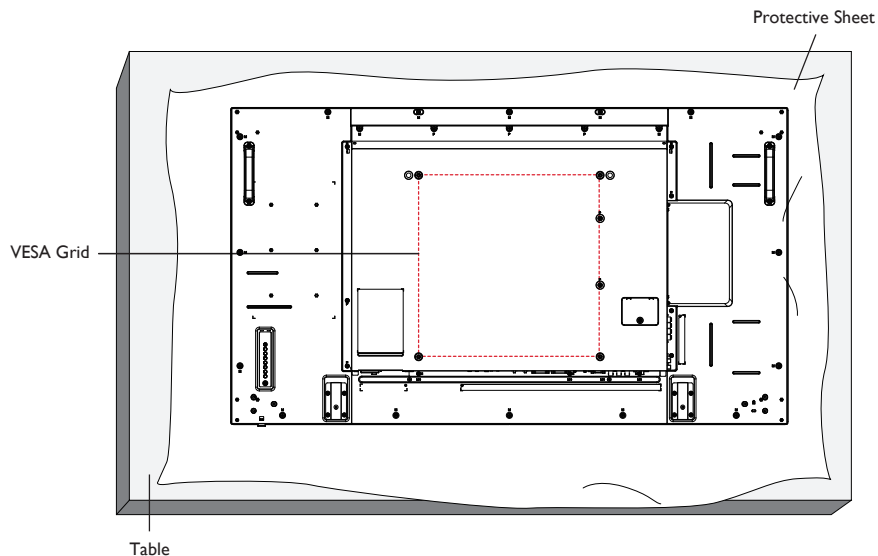

1. Lay a protective sheet on a table, which was wrapped around the display when it was packaged, beneath the screen surface so as not to scratch the screen face.
2. Ensure you have all accessories for mounting this display (wall mount, ceiling mount etc).
3. Before mounting the display to the mounting kit, follow the instructions of 1.4 to collapse the lens.
4. Follow the instructions that come with the base mounting kit. Failure to follow correct mounting procedures could result in damage to the equipment or injury to the user or installer. Product warranty does not cover damage caused by improper installation.
5. For the wall-mounting kit, use M6 mounting screws (having a length 10 mm longer than the thickness of the mounting bracket) and tighten them securely.

1.5.1. VESA Grid

RA-Series	400(H) × 400(V) mm
------------------	--------------------

Caution:

To prevent the display from falling:

- For wall or ceiling installation, we recommend installing the display with metal brackets which are commercially available. For detailed installation instructions, refer to the guide received with the respective bracket.
- To lessen the probability of injury and damage resulting from fall of the display in case of earthquake or other natural disaster, be sure to consult the bracket manufacturer for installation location.

Ventilation Requirements for enclosure locating

To allow heat to disperse, leave 25mm between surrounding objects and the display. For larger video walls, larger gaps around the display are recommended and depend on the size of the wall.

1.6. Mounting in Portrait Position

This display can be installed in portrait position.

1. Rotate 90 degrees counter clockwise from the back side of the display. The terminals will be on the right and top side of the user from the back of the display.
2. You can also refer to the arrow mark on the label on the back cover:

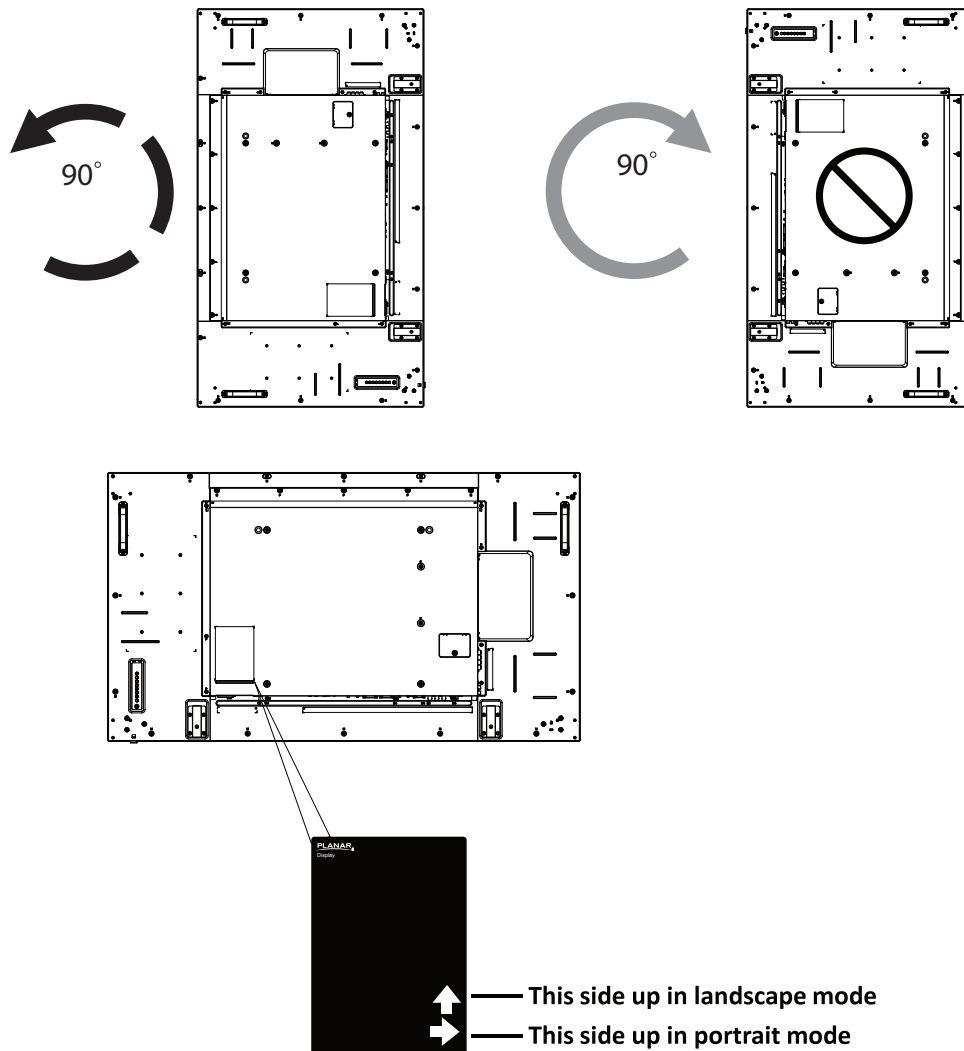

NOTE: When installing the display on a wall, please consult a professional technician for proper installation. We accept no liability for installations not performed by a professional technician.

2. Parts and Functions

2.1. Control Panel

RA4980:

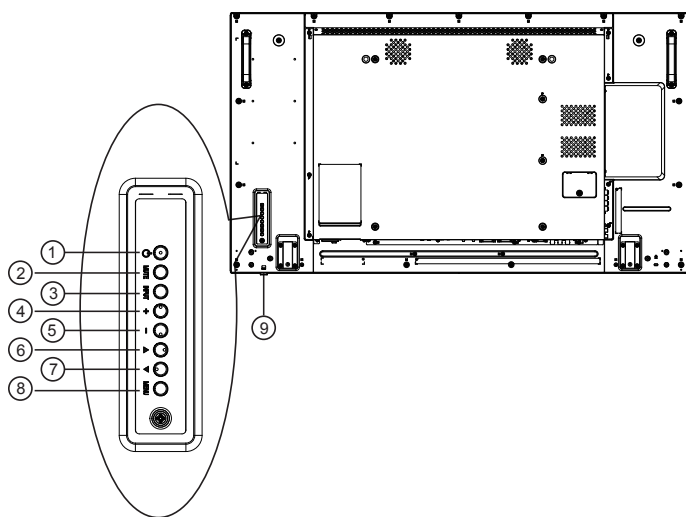

RA5580:

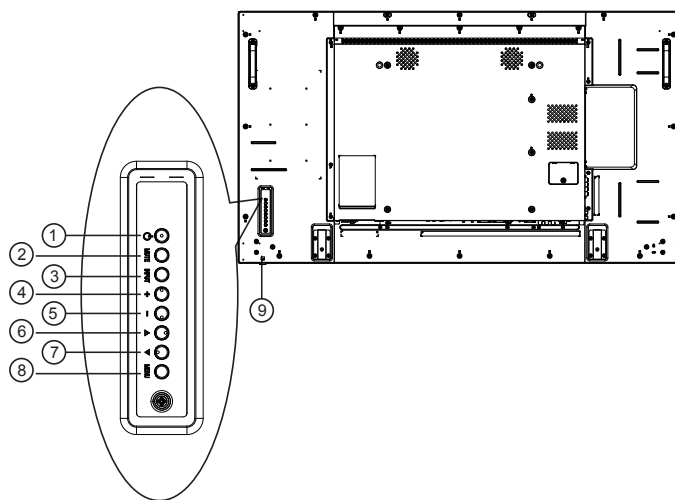

① [⏻] button

Use this button to turn the display on or to put the display into standby mode.

② [MUTE] button

Switch the audio mute ON/OFF.

③ [INPUT] button

Choose the input source.

- Used as [OK] button in the On-Screen-Display menu.

④ [++] button

Increase the adjustment while OSD menu is on, or increase the audio output level while OSD menu is off.

⑤ [–] button

Decrease the adjustment while OSD menu is on, or decrease the audio output level while OSD menu is off.

⑥ [▲] button

Move the highlight bar up to adjust the selected item while OSD menu is on.

⑦ [▼] button

Move the highlight bar down to adjust the selected item while OSD menu is on.

⑧ [MENU] button

Return to previous menu while OSD menu is on, or to activate the OSD menu when OSD menu is off.

⑨ Remote control sensor and power status indicator

- Receives command signals from the remote control.
- Indicates the operating status of the display without OPS:
 - Lights off when the display is turned on
 - Lights amber when the display is in standby mode
 - Lights off when the main power of the display is turned off

2.2. Input/Output Terminals

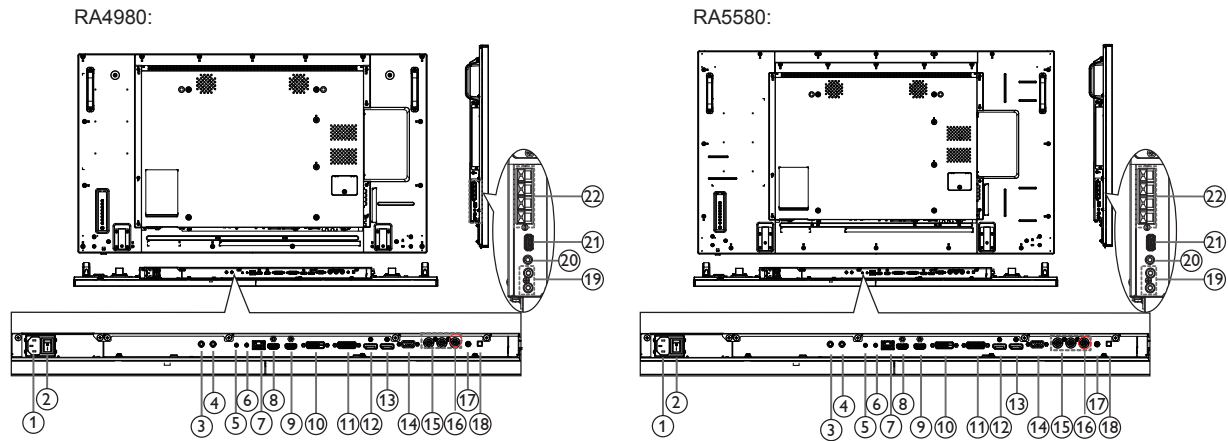

① AC IN

AC power input from the wall outlet.

② MAIN POWER SWITCH

Switch the main power on/off.

③ IR IN / ④ IR OUT

IR signal input / output for the loop-through function.

NOTES:

- This display's remote control sensor will stop working if the jack [IR IN] is connected.
- To remotely control your A/V device via this display, refer to page 13 for IR Pass Through connection.

⑤ RS232C IN / ⑥ RS232C OUT

RS232C network input / output for the loop-through function.

⑦ LAN

LAN control function for remote control from a network.

⑧ HDMI1 IN / ⑨ HDMI2 IN

HDMI video/audio input.

⑩ DVI IN

DVI-D video input.

⑪ DVI OUT

DVI, VGA, HDMI, or OPS video output.

⑫ DisplayPort IN / ⑬ DisplayPort OUT

DisplayPort video input / output.

⑭ VGA IN (D-Sub)

VGA video input.

⑮ COMPONENT VIDEO

Component YPbPr video source input.

⑯ COMPOSITE VIDEO

Video source input.

⑰ PC AUDIO IN

Audio input for VGA source (3.5mm stereo phone).

⑱ SPEAKER SWITCH

Internal speaker on/off switch.

⑲ AUDIO IN

Audio input from external AV device (RCA).

⑳ AUDIO OUT

Audio output to external AV device.

㉑ USB(FW)

For FW update.

㉒ SPEAKERS OUT

Audio output to external speakers.

2.3. Remote Control

2.3.1. General functions

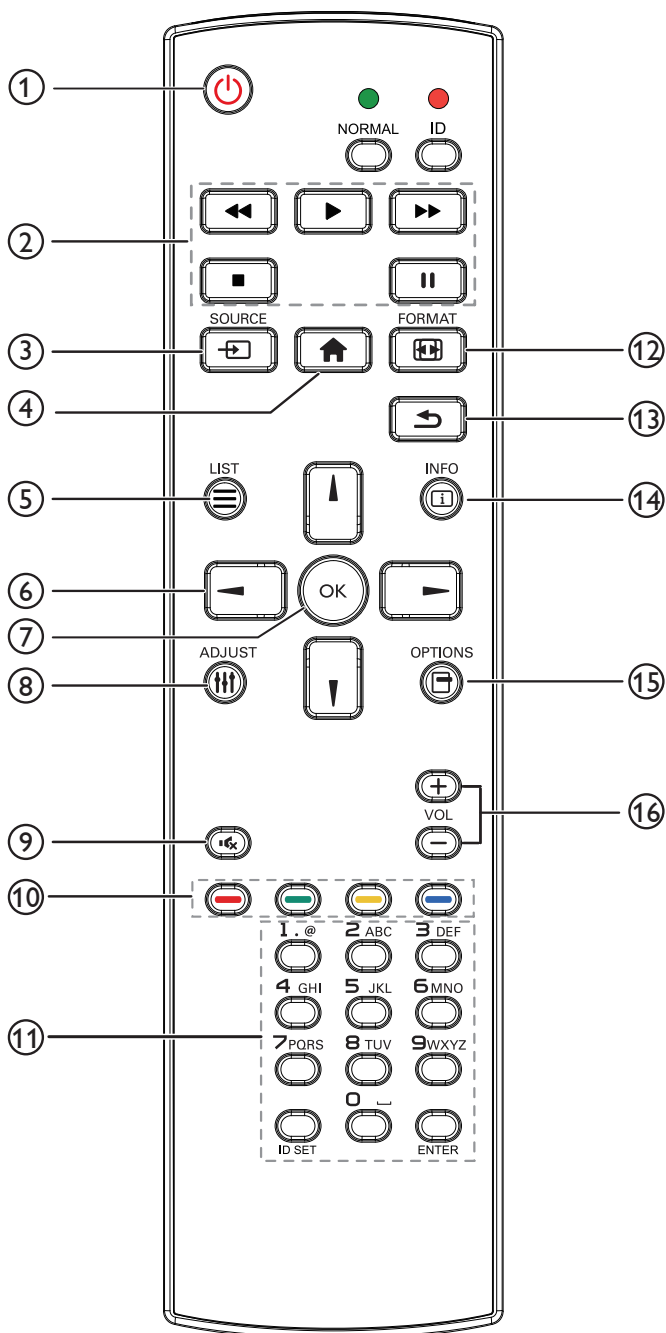

① [POWER] POWER button

Turn the display on or to put the display into standby mode.

② [PLAY] buttons

No function.

③ [SOURCE] SOURCE button

Choose input source. Press [▲] or [▼] button to choose from **HDMI 1, HDMI 2, DisplayPort, Card OPS, DVI-D, YPbPr, AV, or VGA**. Press [OK] button to confirm and exit.

④ [HOME] HOME button

Access the OSD menu.

⑤ [LIST] LIST button

No function.

⑥ [▲] [▼] [←] [→] NAVIGATION buttons

Navigate through menus and choose items.

⑦ [OK] button

Confirm an entry or selection.

⑧ [||||] ADJUST button

Access currently available picture and sound menus.

⑨ [MUTE] MUTE button

Press to turn the mute function on/off.

⑩ [Red] [Green] [Yellow] [Blue] COLOR buttons

Red: Press to turn the tiling enable function on/off.

Green/Yellow/Blue: No function.

⑪ [Number/ ID SET/ ENTER] button

Enter text for network setting.

Press to set the display ID. Refer to **2.3.2. ID Remote Control** for more detail.

⑫ [FORMAT] FORMAT button

Change aspect ratio.

⑬ [BACK] BACK button

Return to the previous menu page or exit from the previous function.

⑭ [i] INFO button

View info about the display.

⑮ [OPTIONS] OPTIONS button

No function.

⑯ [−] [+] VOLUME button

Adjust volume on internal or external audio sources.

2.3.2. ID Remote Control

You can set the remote control ID when you want to use the remote control on specific displays.

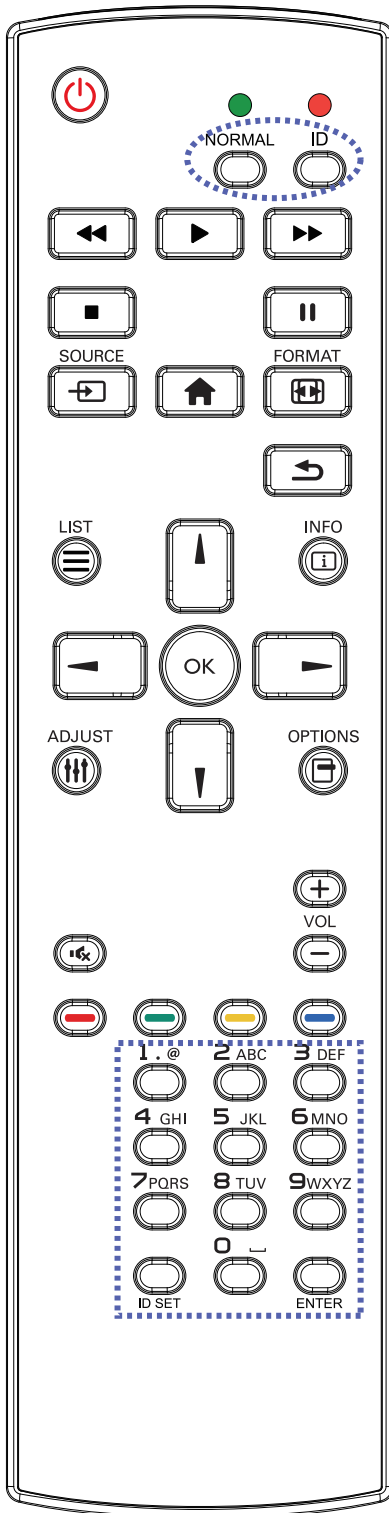

Entering/Leaving ID Mode

To enter ID mode: Press and hold the [ID] button until the red LED blinks twice

To leave ID mode: Press and hold the [NORMAL] button until the green LED blinks twice

Programming ID Mode

To assign an ID to a remote control

1. Enter ID mode
2. Press and hold the [ID SET] button until the red LED turns on
3. Using the numeric keypad, enter the desired ID
4. Press the [ENTER] button to confirm ID
5. The red LED will blink twice when ID has been confirmed

NOTE:

- To cancel or stop programming an ID, press the [ID SET] button.
- Programming of the remote will be automatically canceled if no buttons are pressed for 10 seconds.

2.3.3. Inserting the batteries in the remote control

The remote control is powered by two 1.5V AAA batteries.

To install or replace batteries:

1. Press and then slide the cover to open it.
2. Align the batteries according to the (+) and (-) indications inside the battery compartment.
3. Replace the cover.

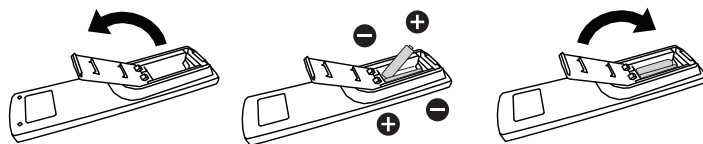

Caution:

The incorrect use of batteries can result in leaks or bursting. Be sure to follow these instructions:

- Place "AAA" batteries matching the (+) and (-) signs on each battery to the (+) and (-) signs of the battery compartment.
- Do not mix battery types.
- Do not combine new batteries with used ones. It causes shorter life or leakage of batteries.
- Remove the dead batteries immediately to prevent them from liquid leaking in the battery compartment. Don't touch exposed battery acid, as it can damage your skin.

NOTE: If you do not intend to use the remote control for a long period, remove the batteries.

2.3.4. Handling the remote control

- Do not subject to strong shock.
- Do not allow water or other liquid to splash the remote control. If the remote control gets wet, wipe it dry immediately.
- Avoid exposure to heat and steam.
- Other than to install the batteries, do not open the remote control.

3. Connecting External Equipment

3.1. Connecting Multiple Displays in a Daisy-chain Configuration

The Planar RA-Series displays are designed to be installed in a daisy-chain configuration for video walls. Note: For larger video wall configurations, a distribution amp is recommended.

3.1.1. Display control connection

RS232

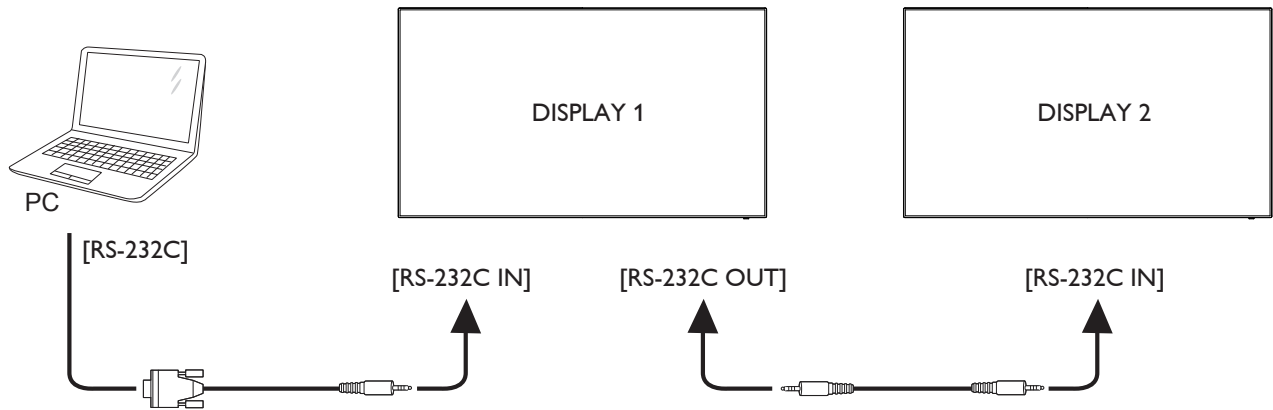

3.1.2. Digital video connection

There are a variety of ways to daisy chain digital signals on the RA-Series.

DVI

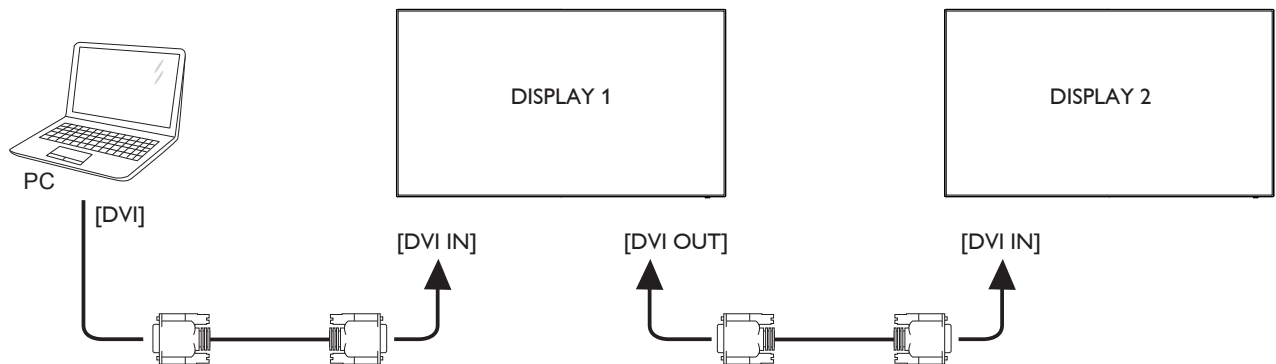

DisplayPort

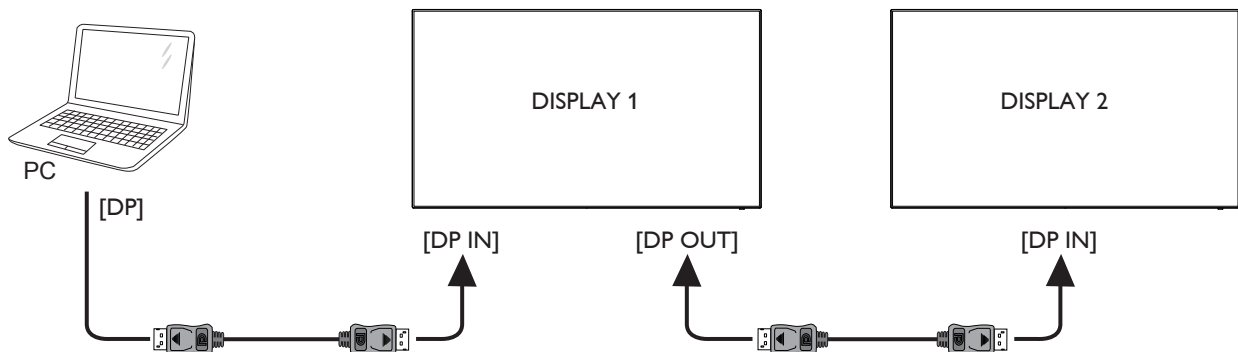

HDMI

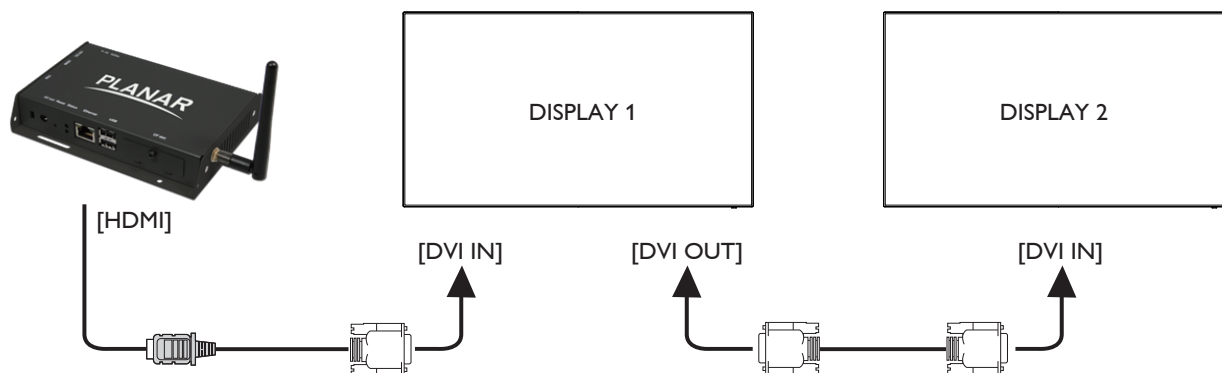

OPS

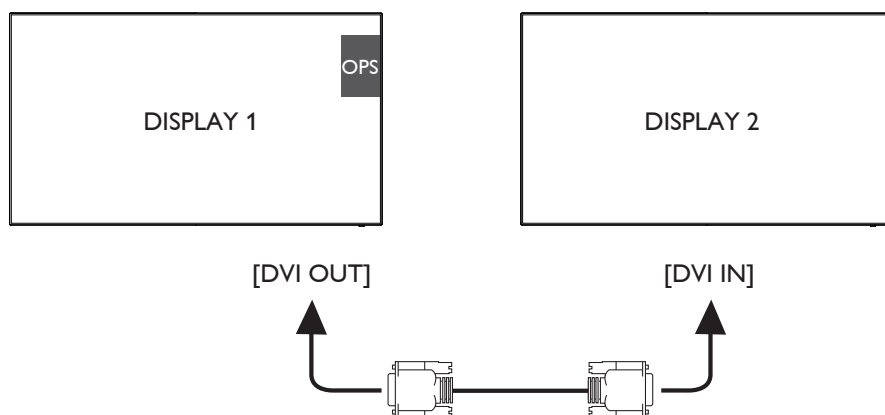

3.1.3. Analog video connection

VGA

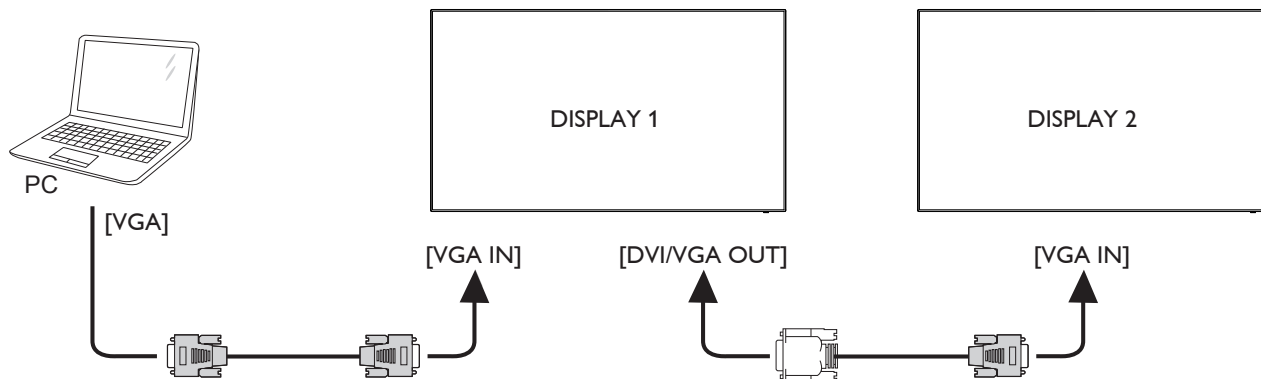

3.2. Connecting Audio Equipment

3.2.1. Connecting external speakers

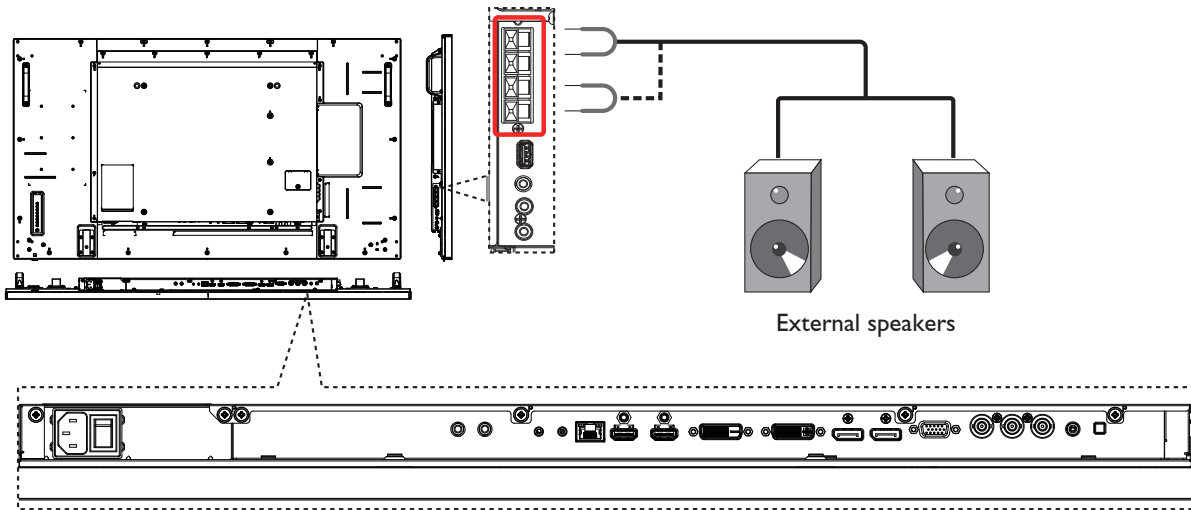

3.2.2. Connecting an external audio device

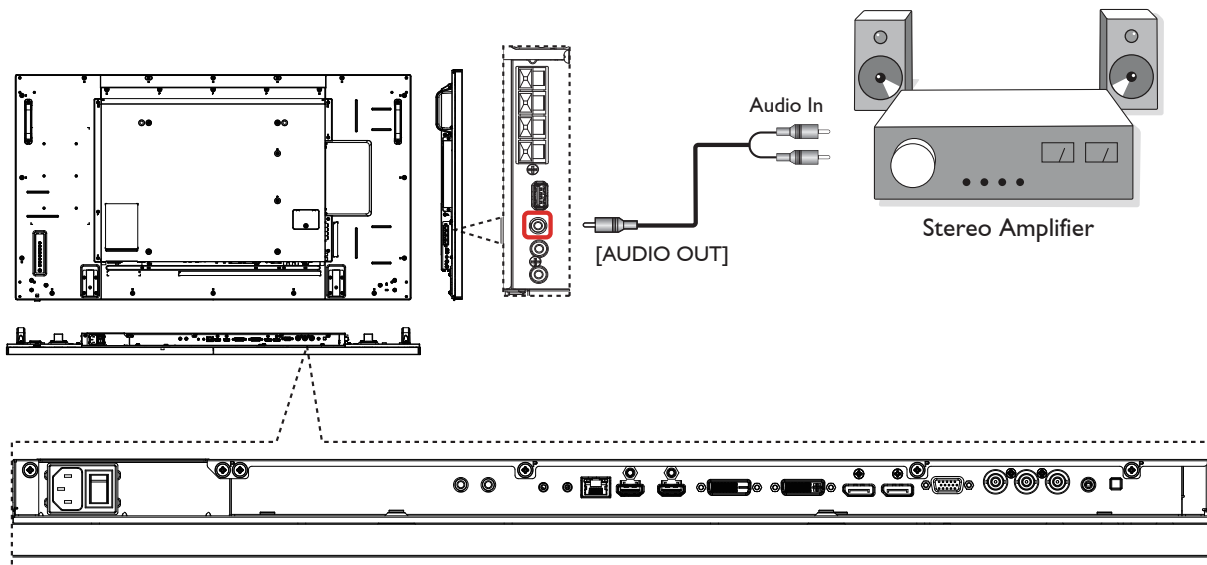

3.3. IR connection

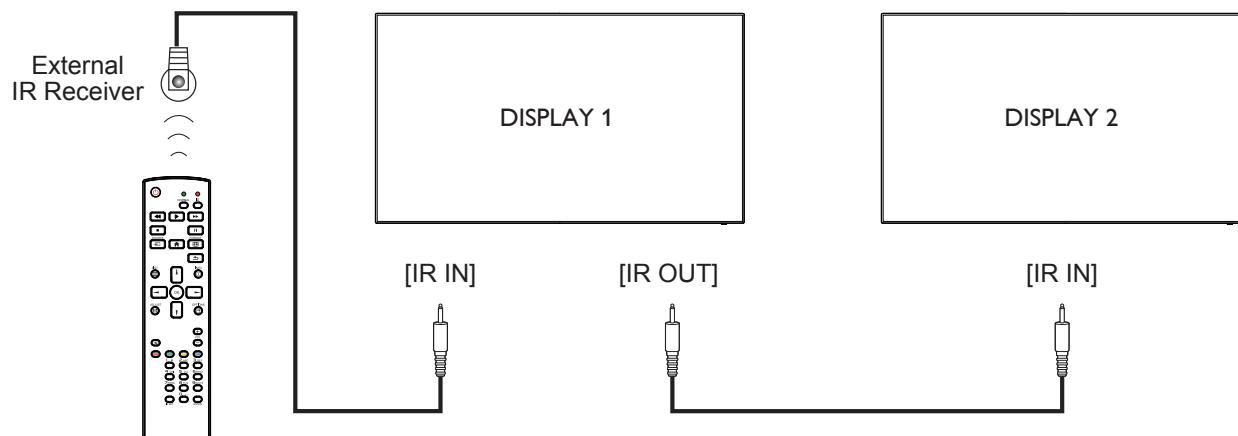

NOTE: This display's remote control sensor will stop working if the [IR IN] is connected.

3.4. IR Pass-through Connection

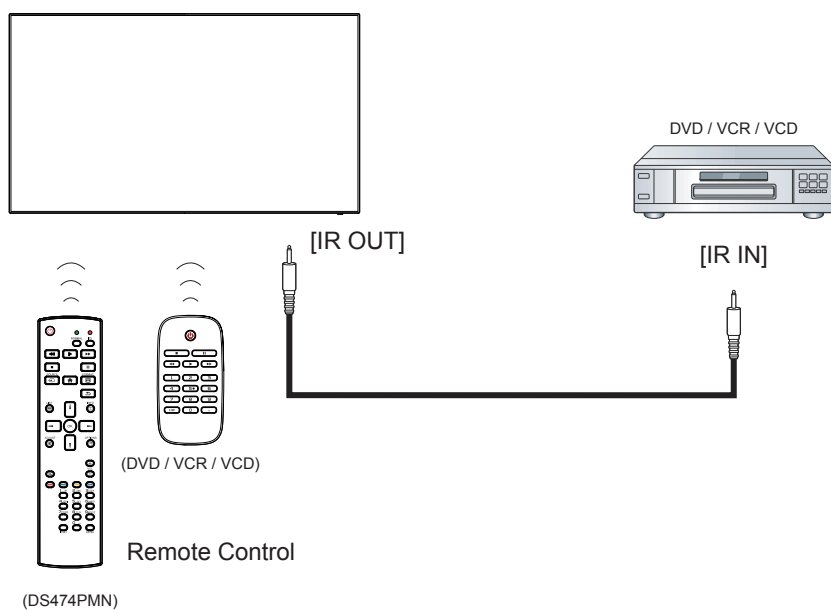

4. Operation

NOTE: The control button described in this section is mainly on the remote control unless specified otherwise.

4.1. Watch the Connected Video Source

1. Press [↔] **SOURCE** button.
2. Press [▲] or [▼] button to choose a device, then press [OK] button.

4.2. Change Aspect Ratio

You can change the aspect ratio to suit the video source. Each video source has its available aspect ratios.

The aspect ratios depend on the video source:

1. Press [≡] **FORMAT** button.
2. Press [▲] or [▼] button to choose an aspect ratio, then press [OK] button.
Options: Auto, Letterbox, Full Screen, Native, 4:3

4.3. Choose your Preferred Picture Settings

1. While the display is playing a video source, press the [≡] **ADJUST** button.
2. Press [←] or [→] button to choose **Picture style**, then press [OK] button.
3. Options: General, Vivid, Natural, Standard, Movie, Photo, Energy Saving

4.4. Choose your Preferred Sound Settings

1. While the display is playing a video source, press [≡] **ADJUST** button.
2. Press [←] or [→] button to choose **Sound style**, then press [OK] button.
Options: General, Original, Movie, Music, Game, News.

4.5. Installing OPS Modules

The Planar RA-Series displays are equipped with an expansion slot that supports the Intel® Open-Pluggable Specification (OPS). The slot will support OPS devices such as PC's, SDI modules, HDBaseT receivers, etc. To install an OPS device, remove the protective cover on the display and slide the device firmly into position. When installed, the OPS device will be connected internally to the display. No external video or power cables are required.

5. Change your settings

Using the remote control:

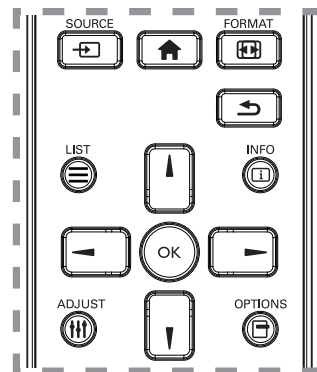

1. Press [HOME] **HOME** button to display the OSD menu.
2. Press [▲] [▼] [←] or [→] button to choose **Picture, Sound, Tiling, General Settings** or **Network settings**. Press [OK] button to enter.
3. Press [▲] [▼] [←] or [→] button to choose its menu item or to adjust its value. Press [OK] button to confirm.
4. Press [↶] **BACK** button to go back to the previous menu layer.
5. Press [HOME] **HOME** button to exit the OSD menu.

Using the display's control buttons

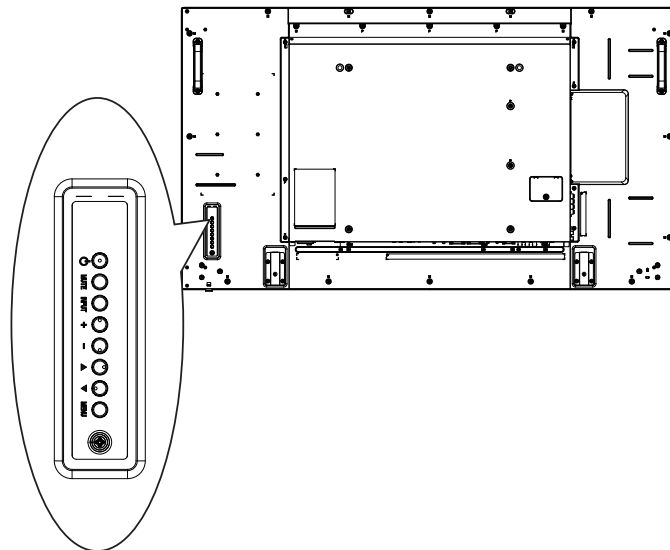

1. Press [MENU] **MENU** button to display the OSD menu.
2. Press [▲] [▼] [+] or [-] button to choose menu item or adjust its value.
3. Press [INPUT] **INPUT** button to confirm menu selection and enter its submenu.
4. Press [MENU] **MENU** button to exit the OSD menu.

5.1. Settings

5.1.1. Picture

Picture	Picture Style	
Sound	Restore Style	
Tiling	Backlight	
General settings	Contrast	
Network settings	Brightness	
	Hue	
	Color	
	Sharpness	
	Noise Reduction	
	Advanced	
	Overscan	
	Color Space	
	Format	

Picture Style

Choose a predefined picture setting.

Options: General, Vivid, Natural, Standard, Movie, Photo, and Energy Saving

Note: YUV sources only.

Restore Style

Restore the picture setting to default values.

Backlight

Adjust the intensity of the display's backlight.

Options: 0-100.

Contrast

Adjust video contrast.

Options: 0-100

Brightness

Adjust screen brightness.

Options: 0-100

Hue

Adjust screen hue.

Options: -50 - +50

Color

Adjust the color saturation of the picture.

Options: 0-100

Sharpness

Adjusts the definition of the picture.

Options: 0-20

Note: YUV sources only.

Noise Reduction

Choose the amount of noise reduction for the picture.

Options: Off, Low, Medium, High

Note: YUV sources only

Advanced

- **{Gamma}**: Adjust the non-linear setting for picture luminance and contrast.
Options: 1.8, 1.9, 2.0, 2.1, 2.2, 2.3, 2.4, 2.5

- **{Color Temp}**: Change the color balance.
Options: 10000K, 9300K, 6500K, 3200K, Custom
- **{Custom Color Temp}**: Customize color balance setting. Only available if **{Color Temp}** → **{Custom}** is chosen.
 - R-Gain
Options: 0 - 255
 - G-Gain
Options: 0 - 255
 - B-Gain
Options: 0 - 255
 - R-Offset
Options: 0 - 255
 - G-Offset
Options: 0 - 255
 - B-Offset
Options: 0 - 255
- **{Advanced Sharpness}**: Enable superior sharpness, especially on lines and contours in the picture.
Options: Off, On
- **{Dynamic Contrast}**: Dynamically enhance the details in the dark, medium and light areas of the picture.
Options: Off, Low, Medium, High
- **{Color Enhancement}**: Dynamically enhance the vividness and details of colors.
Options: Off, Low, Medium, High
- **{Dynamic Backlight}**: Choose a backlight level which optimizes dynamic power consumption and picture contrast.
Options: Off, Standard, Best Power, Best Picture.

Overscan

Enables or disables the overscan function.

Options: Off, On

Note: YUV sources only

Color Space

Select the color space of the source signal.

Options: Auto, RGB-Video, RGB-PC, YUV

Format

- **{Aspect Ratio}**: Change the picture format.
Options: Auto, Letterbox, Full Screen, Native, 4:3
- **{Picture Shift}**:
Adjust position of image.

5.1.2. Sound

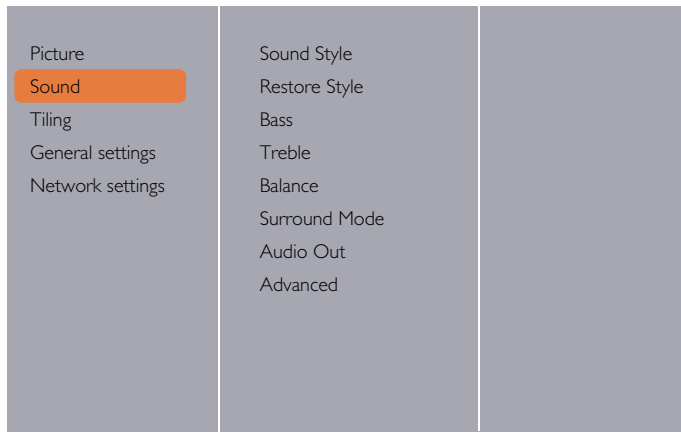

Sound Style

Access predefined sound settings.

Options: General, Original, Movie, Music, Game, News

Restore Style

Restore the sound setting to default values.

Bass

Adjust to increase or decrease lower-pitched sounds.

Options: -8 - +8

Treble

Adjust to increase or decrease higher-pitched sounds.

Options: -8 - +8

Balance

Adjust to emphasize left or right audio output balance.

Options: -8 - +8

Surround Mode

Enhance your audio experience.

Options: Off, On

Audio Out

Adjust audio output volume. For line out audio sources only.

Options: 0 - 60

Advanced

- **{Auto Volume Leveling}**: Enable the reduction of sudden volume changes.
Options : Off, On
- **{Internal Speakers}**: Turn on or off the internal speakers.
Options : Off, On
- **{Clear Sound}**: Enhance sound quality.
Options : Off, On

5.1.3. Tiling



Enable

Enable video wall scaling

Options: Off, On

H Monitors

Adjust displays on the horizontal side.

Options: 1 - 10

V Monitors

Adjust displays on the vertical side.

Options: 1 - 10

Position

Assign the position of the display in the video wall configuration

Options: 1 – 100

Example: 2 x 2 screen matrix (4 displays)

H monitors = 2 displays

V monitors = 2 displays

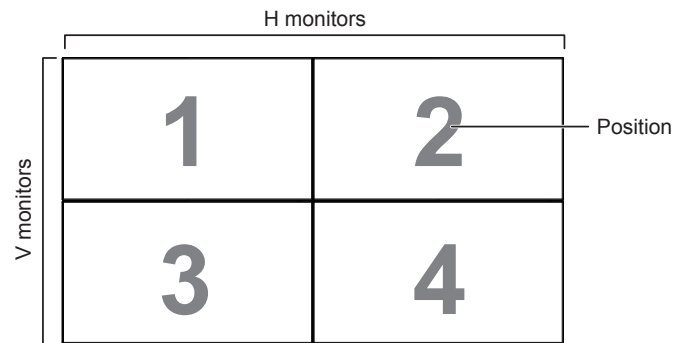

Example: 5 x 5 screen matrix (25 displays)

H monitors = 5 displays

V monitors = 5 displays

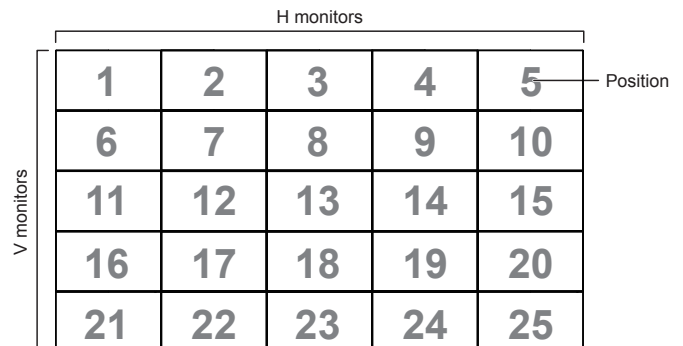

Frame Comp

Choose to turn the frame compensation function on or off. If selected {On}, the display will adjust the image to compensate for the width of the display bezels in order to accurately display the image.

On}

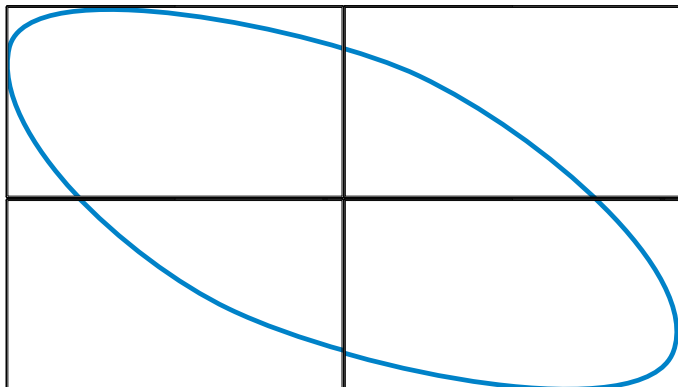

{Off}

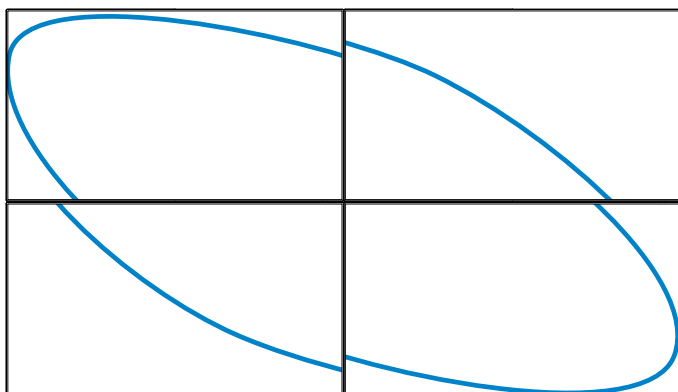

Hor and Vert Frame Compensation

Provides variable adjustment horizontally or vertically for more precise video wall frame compensation.

5.1.4. General settings

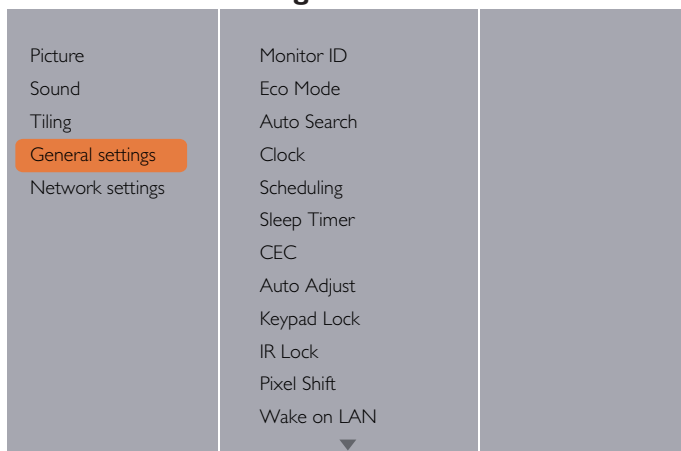

Monitor ID

Adjust the ID number for controlling the display via the RS232C connection. Each display must have a unique ID number when multiple sets of this display are connected. Monitor ID number range is between 1 to 255. The default setting is 1.

Eco Mode

Select standby power consumption setting.

Options: Normal, Low power standby

Note: For the lowest standby power consumption, select Low power standby. When the Eco mode is set to Low power standby, the display cannot wake from sleep. When the Eco mode is set to Normal, the display can wake from sleep. See Auto Search Setting for more information on how to wake the display.

Auto Search

Automatically detects available input sources when "On". If "Backup Source" is selected, assigned sources in designated sequential order will be searched. When "Off" the display will automatically detect the last input.

Options: Off, On, Backup Source (Select up to 7)

Note: When set to "On", the last input will wake the display. When set to "Off", the last input will wake the display. When set to "Off", a RS-232 command can wake the display using any input. When set to "Backup source", any active backup source (in sequential order) will wake the display. Note that Eco Mode needs to be set to "Normal" for the display to wake up.

Clock

Set the current date (DD-MM-YYYY) and time

Scheduling

This function allows you to program up to 7 different scheduled time intervals for this display to activate.

NOTES:

- Set up current date and time in the {Clock} menu before setting up a schedule.
- After changing the date and time in the {Clock} menu, the schedule may need to be re-entered.

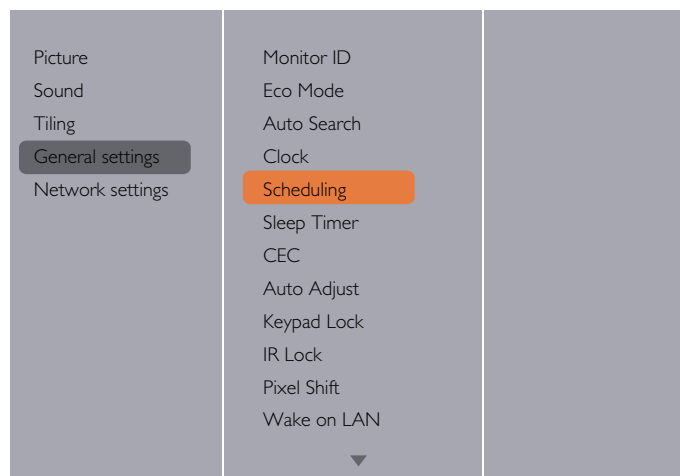

1. Up to 7 schedules can be programmed. To activate a schedule, select **Enable** and choose **On**.

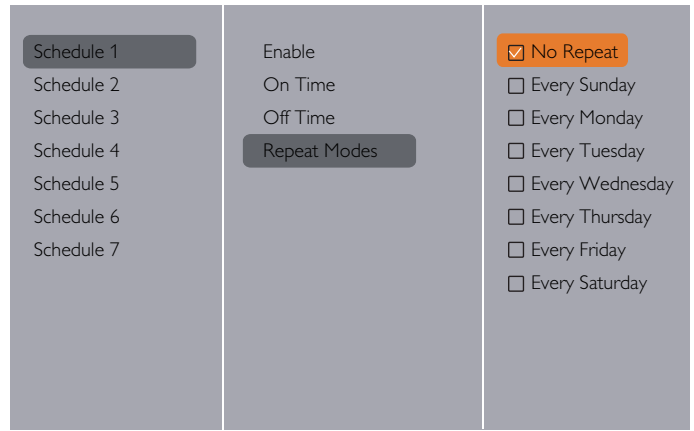
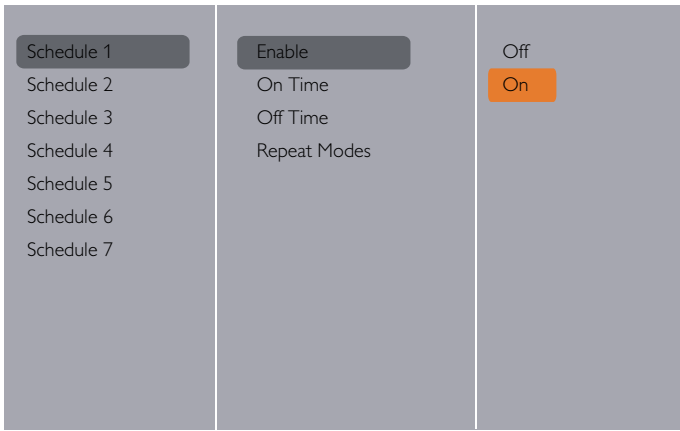

2. Set **On time**.

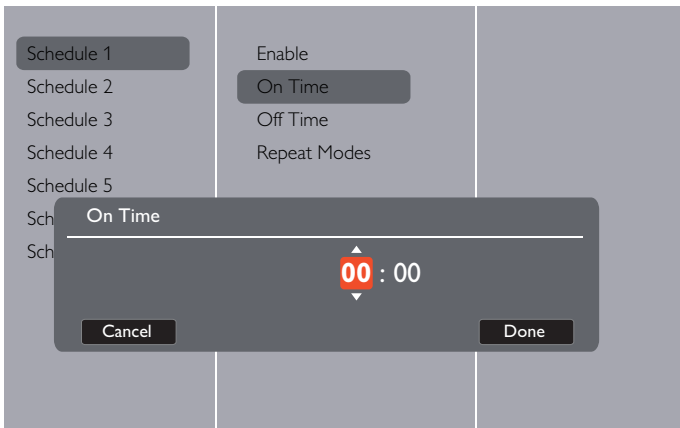

Sleep Timer

Switch off this display after a specified time.

Options: 0-240 seconds

CEC

Connect and control your HDMI-CEC compliant devices through the HDMI port of this display using the same remote control.

Options: Off, On

Auto Adjust

Use this function to automatically optimize the display of VGA input image.

NOTE: This item is functional for **VGA** input only.

Keypad Lock

Choose to enable or disable the keypad function on the backside of the display.

- Unlock: Enable the keypad function.
- Lock: Lock the keypad function.

IR Lock

Choose to enable or disable the button function of the remote control.

- {Unlock}: Enable the IR Remote function.
- {Lock}: Lock all IR Remote function.

NOTE: To disable the lock function from **Keypad Lock** or **IR lock** item, press buttons [Home] and **1 9 9 8** on the remote control.

Pixel Shift

Automatically moves the screen image every 30 minutes to protect the display from "burn-in" symptoms.

Options: Off, On

Wake on LAN

Wake the display through a network connection.

Options: Off, On

Switch on State

Choose the display status used for the next time you connect the power cord.

Options: On, Standby, Last Status

LED

Enables or disables the indicator light

Options: Off, On

3. Set **Off Time**.

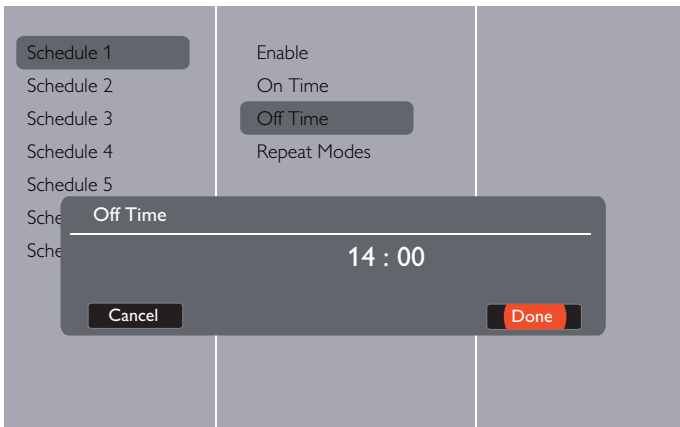

4. Go to **Repeat Modes** and choose.

Switch on Delay

Adjusts the power-on delay time for sequential powering of displays by their ID number.

Options: 0 – 60 seconds

Splash Screen

Enables or disables the splash screen during start up

Options: Off, On

Auto Power

Select the time period before the display will turn off when there is no signal. By choosing off, the display will never power down.

Options: Off, 1-60 seconds

Information OSD

When you press **[POWER]** button to turn on the display from standby mode or change the input signal, the information OSD is displayed on the upper left corner of the screen.

Choose **{On}** to turn on this function.

Choose **{Off}** to turn off this function.

DisplayPort Ver.:

Select DisplayPort version.

Options: 1.1a, 1.2.

Cooling Fan

Select **{On}** to turn on the cooling fan all the time. Select **{Auto}** to turn on/off the cooling fan according to the display's temperature.

Select **{Off}** to turn off the cooling fan.

NOTES:

- The default **{Auto}** option will start running the cooling fan if the temperature of 60°C (140°F) is reached.

RS-232 Control

Select the RS-232 control location

Options: External, OPS

OSD Time Out

Set OSD menu display time

Options: 10 – 60 sec.

Factory Settings

Reset all your customized settings to the factory defaults.

5.2. Network Settings

- Press **[HOME]** button, choose **Network Settings** and press **[OK]** button.

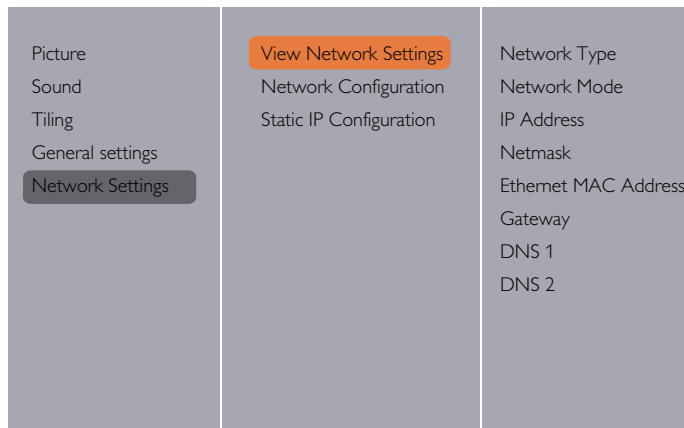
**View Network Settings**

View connected network status.

Network Configuration

{Network configuration}: Choose how this display should assign addresses to the network resources.

The user can choose **{DHCP & Auto IP}** (suggested) or **{Static IP}**.

Static IP Configuration

Define **{IP Address}**, **{Netmask}**, **{Gateway}**, **{DNS1}**, and **{DNS2}** for this display. If **{Network settings}** → **{Static IP}** is chosen.

6. Input Mode

VGA Resolution:

Standard Resolution	Active Resolution		Refresh Rate	Pixel Rate	Aspect Ratio	Stand for Mode
	H Pixels	V Lines				
VGA	640	480	60 Hz	25.175 MHz	4:3	Video Graphic Array
			72 Hz	31.5 MHz		
			75 Hz	31.5 MHz		
WVGA	720	400	70 Hz	33.75 MHz	16:9	Wide Video Graphic Array
SVGA	800	600	60 Hz	40 MHz	4:3	Super VGA
			75 Hz	49.5 MHz		
XGA	1024	768	60 Hz	65 MHz	4:3	Extended Graphic Array
			75 Hz	78.75 MHz		
WXGA	1280	768	60 Hz	79.5 MHz	5:3	Wide XGA
WXGA	1280	800	60 Hz	79.5 MHz	16:10	Wide XGA
SXGA	1280	1024	60 Hz	108 MHz	5:4	Super XGA
WXGA	1360	768	60 Hz	85.5 MHz	16:9	Wide XGA
WXGA	1366	768	60 Hz	85.5 MHz	16:9	Wide XGA
UXGA	1600	1200	60 Hz	162 MHz	4:3	Ultra XGA
HD1080	1920	1080	60 Hz	148.5 MHz	16:9	HD1080

SDTV Resolution:

Standard Resolution	Active Resolution		Refresh Rate	Pixel Rate	Aspect Ratio	Stand for Mode
	H Pixels	V Lines				
480i	720	480	29.97 Hz	13.5 MHz	4:3	Modified NTSC Standard
480p			59.94 Hz	27 MHz		
576i	720	480	25 Hz	13.5 MHz	4:3	Modified PAL Standard
576p			50 Hz	27 MHz		

HDTV Resolution:

Standard Resolution	Active Resolution		Refresh Rate	Pixel Rate	Aspect Ratio	Stand for Mode
	H Pixels	V Lines				
720p	1280	720	50 Hz	74.25 MHz	16:9	Normally DVB Mode
			60 Hz			
1080i	1920	1080	25 Hz	74.25 MHz	16:9	Normally ATSC Mode
			30 Hz			
1080p	1920	1080	50 Hz	148.5 MHz	16:9	Normally ATSC Mode
			60 Hz			

UHDTV Resolution:

UHDTV Resolution	Active Resolution		Refresh Rate	Pixel Rate	Aspect Ratio	Stand for Mode
	H Pixels	V Lines				
	3840	2160	30	297MHz	16:9	Video wall application.

Note: UHD resolution is supported only on video wall arrays. Each individual LCD display supports a max resolution of 1080p.

7. Troubleshooting

Symptom	Possible Cause	Remedy
No picture is displayed	<ol style="list-style-type: none"> 1. The power cord is disconnected. 2. The main power switch on the back of the display is not switched on. 3. The selected input has no connection. 4. The display is in standby mode. 	<ol style="list-style-type: none"> 1. Plug in the power cord. 2. Make sure the power switch is switched on. 3. Connect a signal connection to the display.
Interference displayed on the display or audible noise is heard	Caused by surrounding electrical appliances or fluorescent lights.	Move the display to another location to see if the interference is reduced.
Color is abnormal	The signal cable is not connected properly.	Make sure that the signal cable is attached firmly to the back of the display.
Picture is distorted with abnormal patterns	<ol style="list-style-type: none"> 1. The signal cable is not connected properly. 2. The input signal is beyond the capabilities of the display. 	<ol style="list-style-type: none"> 1. Make sure that the signal cable is attached firmly. 2. Check the video signal source to see if it is beyond the range of the display. Please verify its specifications with this display's specification section.
Display image doesn't fill up the full size of the screen	<ol style="list-style-type: none"> 1. The zoom mode is not set correctly. 2. Scan Mode may be set incorrectly to underscan. 3. If the image exceeds the screen size, Scan Mode may need to be set to Underscan. 	Use the Zoom mode or Custom zoom function in the Screen menu to fine tune display geometry and time frequency parameter.
Can hear sound, but no picture	Improperly connected source signal cable.	Make sure that both video inputs and sound inputs are correctly connected.
Can see picture but no sound is heard	<ol style="list-style-type: none"> 1. Improperly connected source signal cable. 2. Volume is turned all the way down. 3. {Mute} is turned on. 4. No external speaker connected. 	<ol style="list-style-type: none"> 1. Make sure that both video inputs and sound inputs are correctly connected. 2. Press [+] or [-] button to hear sound. 3. Switch MUTE off by using the [MUTE] button. 4. Connect external speakers and adjust the volume to a suitable level.
Some picture elements do not light up	Some pixels of the display may not turn on.	This display is manufactured using an extremely high level of precision technology; however, sometimes some pixels of the display may not display. This is not a malfunction.
After-Images can still be seen on the display after the display is powered off. (Examples of still pictures include logos, video games, computer images, and images displayed in 4:3 normal mode)	A still picture is displayed for an over extended period of time	Do not allow a still image to be displayed for an extended period of time as this can cause a permanent after-image to remain on the display.

8. Technical Specifications

8.1. RA4980

Display:

Item	Specifications
Screen Size (Active Area)	48.50" (123.2 cm) LCD
Aspect Ratio	16:9
Number of pixels	1920 (H) x 1080 (V)
Pixel pitch	0.55926 (H) x 0.55926 (V) [mm]
Displayable colors	10bits(D),1.06 Billion colors
Brightness (typical)	700 cd/m ²
Contrast ratio (typical)	1300:1
Viewing angle	178 degrees

In/Out Terminals:

Item	Specifications
Speaker Output	Internal Speakers External Speakers
Audio Output	Phone Jack x 1
Audio Input	RCA Jack x 2 3.5 mm Stereo x 1
RS232C	2.5mm Phone jack x 2
RJ-45	RJ-45 Jack x 1 (8 pin)
HDMI Input	HDMI Jack x 2 (Type A) (18 pin)
DVI-D Input	DVI-D jack
VGA Input	D-Sub Jack x 1 (15 pin)
DVI-I (DVI-D & VGA) Output	DVI-I Jack x 1 (29 pin)
Component Input	BNC Jack x 3
Video Input	BNC x 1 (Share with Component_Y)
Displayport in/out	Displayport Jack x 2 (20 pin)

General:

Item	Specifications
Power Input	100 - 240V ~, 50 - 60Hz
Power Consumption (Max)	240 W
Power Consumption (typ.)	120 W
Power Consumption (Standby & Off)	<0.5W (RS232 in active)
Dimensions [W x H x D]	1092.3 x 622.5 x 71.1(@Handle)/56.8(@Wall Mount)mm
Weight	19.0 Kg
Gross Weight	25.3 Kg

Environmental Condition:

Item	Specifications	
Temperature	Operational	0 ~ 40°C
	Storage	-20 ~ 60°C
Humidity	Operational	20 ~ 80% RH (No condensation)
	Storage	5 ~ 95% RH (No condensation)
Altitude	Operational	0 ~ 3,000 m
	Storage / Shipment	0 ~ 9,000 m

Internal Speaker:

Item	Specifications
Type	1 Way 1 Speaker
Input	10 W (RMS)
Impedance	8Ω
Output Sound Pressure	82 dB/W/M
Frequency Response	160 Hz ~ 13 KHz

8.2. RA5580

Display:

Item	Specifications
Screen Size (Active Area)	54.64" (138.78 cm) LCD
Aspect Ratio	16:9
Number of pixels	1920 (H) × 1080 (V)
Pixel pitch	0.630 (H) × 0.630 (V) [mm]
Displayable colors	10bits(D), 1.06 Billion colors
Brightness (typical)	700 cd/m ²
Contrast ratio (typical)	1300:1
Viewing angle	178 degrees

In/Out Terminals:

Item	Specifications
Speaker Output	Internal Speakers External Speakers
	10W (L) + 10W (R) [RMS]/8Ω 1 Way 1 Speaker System 82 dB/W/M/160 Hz ~ 13 KHz
Audio Output	Phone Jack × 1
	0.5V [rms] (Normal) / 2 Channel (L+R)
Audio Input	RCA Jack × 2 3.5 mm Stereo × 1
	0.5V [rms] (Normal) / 2 Channel (L+R)
RS232C	2.5mm Phone jack × 2
	RS232C in/RS232C out
RJ-45	RJ-45 Jack × 1 (8 pin)
	10/100 LAN Port
HDMI Input	HDMI Jack × 2 (Type A) (18 pin)
	Digital RGB: TMDS (Video + Audio) MAX: Video - 720p, 1080p, 1920 × 1080/60 Hz (WUXGA) Audio - 48 KHz/ 2 Channel (L+R) Supports LPCM only
DVI-D Input	DVI-D jack
	Digital RGB: TMDS (Video)
VGA Input	D-Sub Jack × 1 (15 pin)
	Analog RGB: 0.7V [p-p] (75Ω), H/CS/V: TTL (2.2kΩ), SOG: 1V [p-p] (75Ω) MAX: 720p, 1080p, 1920 × 1080/60 Hz (WUXGA)
DVI-I (DVI-D & VGA) Output	DVI-I Jack × 1 (29 pin)
	Digital RGB: TMDS (Video) Analog RGB: 0.7V [p-p] (75Ω), H/CS/V: TTL (2.2kΩ), SOG: 1V [p-p] (75Ω) MAX: 720p, 1080p, 1920 × 1080/60 Hz (WUXGA)
Component Input	BNC Jack × 3
	Y: 1V [p-p] (75Ω), Pb: 0.7V [p-p] (75Ω), Pr: 0.7V [p-p] (75Ω) MAX: 480i, 576i, 480p, 576p, 720p, 1080i, 1080p
Video Input	BNC × 1 (Share with Component_Y)
	Composite 1V [p-p] (75Ω)
Displayport in/out	Displayport Jack × 2 (20 pin)
	Digital RGB: TMDS (Video + Audio) MAX: Video - 720p, 1080p, 1920 × 1080/60 Hz (WUXGA) Audio - 48 KHz/ 2 Channel (L+R) Supports LPCM only

General:

Item	Specifications
Power Input	100 - 240V ~, 50 - 60Hz,
Power Consumption (Max)	265 W
Power Consumption (typ.)	145 W
Power Consumption (Standby & Off)	<0.5W (RS232 in active)
Dimensions [W x H x D]	1228.1 x 698.9 x 71.1(@Handle)/56.8(@Wall Mount)mm
Weight	24.7 Kg
Gross Weight	31.4 Kg

Environmental Condition:

Item	Specifications	
Temperature	Operational	0 ~ 40°C
	Storage	-20 ~ 60°C
Humidity	Operational	20 ~ 80% RH (No condensation)
	Storage	5 ~ 95% RH (No condensation)
Altitude	Operational	0 ~ 3,000 m
	Storage / Shipment	0 ~ 9,000 m

Internal Speaker:

Item	Specifications
Type	1 Way 1 Speaker
Input	10 W (RMS)
Impedance	8Ω
Output Sound Pressure	82 dB/W/M
Frequency Response	160 Hz ~ 13 KHz

PLANAR SUPPORT

Technical Support

Visit Planar at <http://www.planar.com/support> for user manuals and warranty information.

To speak with Planar Customer Support please have you model and serial number available and dial:

Planar Support

Tel: 1-866-PLANAR1 (866-752-6271) or +1 503-748-5799 outside the US.

Hours: 24 hours a day, 7 days a week.

Toll or long distance charges may apply.

Planar Systems, Inc.

Customer Service

24x7 Online Technical Support :<http://www.planar.com/support>

1195 NW Compton Drive

Beaverton,OR 97006-1992

Tel:1-866-PLANAR1(866-752-6271),or +1 503-748-5799 outside the United States.

©2015 Planar Systems,Inc.

Planar is a registered trademark of Planar Systems,Inc. Other brands and names are the property of their respective owners. Technical information in this document is subject to change without notice.



PN: 020-1281-00