



PS Series

USER'S GUIDE

www.planar.com

Planar utilizes HDMI® standards in this product.

The terms HDMI, HDMI High-Definition Multimedia Interface, HDMI Trade dress and the HDMI Logos are trademarks or registered trademarks of HDMI Licensing Administrator, Inc.

The information contained in this document is subject to change without notice. This document contains proprietary information that is protected by copyright. All rights are reserved. No part of this document may be reproduced, translated to another language or stored in a retrieval system, or transmitted by any means, electronic, mechanical, photocopying, recording, or otherwise, without prior written permission.

Windows is a registered trademark of Microsoft, Inc.

Other brands or product names are trademarks of their respective holders.

Important Recycle Instruction:



LCD Lamp(s) inside this product contain mercury. This product may contain other electronic waste that can be hazardous if not disposed of properly. Recycle or dispose in accordance with local, state, or federal Laws. For more information on how to recycle your product, please visit WWW.PLANARSYSTEMS.COM/GREEN.

Revision Control	
DATE:	DESCRIPTION:
<i>May 2011</i>	<i>Document number 020-1146-00 Rev. A.</i>

Table of Contents

Safety Warnings and Precautions	1
Important Safety Instructions	2
Regulatory Compliance Notices	2
FCC Compliance Notice	2
For Canada	3
Notes on the LCD Panel of This Display	3
Copyright	3
Disclaimer	3
Package Contents	4
Parts of the Display and Their Functions	5
Front Panel	5
Rear Panel	5
Input/Output Terminals	6
Remote Control.....	7
Using the Remote Control	8
Installing Remote Control Batteries.....	8
Remote Control Usage Tips	8
Battery Safety Notice.....	8
Setting Up the Display	9
Mounting the Display	9
Connecting Audio/Video Signals	10
Connecting the VGA Input.....	10
Connecting the Digital Input	11
Connecting the YPbPr Component Video Input.....	12
Connecting the AV and S-Video Inputs.....	13
Connecting External Speakers.....	14
Connecting Multiple Displays.....	15
Connecting the Touch Module	16
Connecting Power	17
Using the Touch Screen.....	18
Calibrating the Touch Screen	21
Important Instructions for Using the Touch Screen	21
Basic Operations	22
Turning the Display On or Off.....	22
Locking/Unlocking the Controls.....	22
Control Panel Buttons.....	22
OSD Menu Function	22

Power On/Off Function	22
Remote Control Functions	22
Switching Input Signals	22
Adjusting Audio Volume Level	22
The OSD (On-Screen Display) Menu	23
OSD Menu Overview.....	23
Operations in the OSD Menu.....	24
Picture Menu.....	25
Adjusting the Contrast	25
Adjusting the Brightness	25
Sound Menu.....	26
Option Menu.....	27
Setting Menu	28
Product Information	30
Specifications	30
Supported Input Signal Resolution	31
Supported PIP Input Signal Combination.....	32
Supported Signal Source and Resolution in PIP Mode	33
Troubleshooting.....	42

Safety Warnings and Precautions



The lightning flash with arrowhead symbol, within an equilateral triangle, is intended to alert the user to the presence of uninsulated "dangerous voltage" within the product's enclosure that may be of sufficient magnitude to constitute a risk of electric shock to persons.



The exclamation point within an equilateral triangle is intended to alert the user to the presence of important operating and maintenance (servicing) instructions in the literature accompanying the appliance.

THIS EQUIPMENT MUST BE GROUNDED

To ensure safe operation, the three-pin plug must be inserted only into a standard three-pin power outlet which is effectively grounded through normal household wiring. Extension cords used with the equipment must have three cores and be correctly wired to provide connection to the ground. Wrongly wired extension cords are a major cause of fatalities.

The fact that the equipment operates satisfactorily does not imply that the power outlet is grounded or that the installation is completely safe. For your safety, if you are in any doubt about the effective grounding of the power outlet, please consult a qualified electrician.

- The mains plug of the power supply cord shall remain readily operable. The AC receptacle (mains socket outlet) shall be installed near the equipment and shall be easily accessible. To completely disconnect this equipment from the AC mains, disconnect the power cord plug from the AC receptacle.
- Do not place this display on an uneven, sloping or unstable surface (such as a trolley) where it may fall and cause damage to itself or others.
- Do not place this display near water, like a spa or pool, or in a position which will allow the splashing or spraying of water onto the display, like in front of an open window where rain water may enter.
- Do not install this display in a confined space without proper ventilation and air circulation, such as in a closed cabinet. Allow proper space around the display for dissipating heat inside. Do not block any openings and vents on the display. Overheating may result in hazards and electric shock.
- Installation of this display should only be performed by a qualified technician. Failure to install this display properly may cause injuries and damages to the personnels and the display itself. Check the installation regularly and maintain the display periodically to ensure the best working condition.
- Use only the accessories approved or recommended by the manufacturer to mount this display. Using wrong or unsuitable accessories may cause the display to fall and result in serious personal injuries. Make sure that the surface and fixing points are strong enough to sustain the weight of the display.
- To reduce the risk of electric shock, do not remove covers. No user serviceable parts inside. Refer servicing to qualified service personnel.

Important Safety Instructions

1. Read these instructions.
2. Keep these instructions.
3. Heed all warnings.
4. Follow all instructions.
5. Do not use this apparatus near water.
6. Clean only with dry cloth.
7. Do not block any ventilation openings. Install in accordance with the manufacturer's instructions.
8. Do not install near any heat sources such as radiators, heat registers, stoves, or other apparatus (including amplifiers) that produce heat.
9. Do not defeat the safety purpose of the polarized or grounding-type plug. A polarized plug has two blades with one wider than the other. A grounding-type plug has two blades and a third grounding prong. The wide blade or the third prong are provided for your safety. If the provided plug does not fit into your outlet, consult an electrician for replacement of the obsolete outlet.
10. Protect the power cord from being walked on or pinched particularly at plugs, convenience receptacles, and the point where they exit from the apparatus.
11. Only use attachments/accessories specified by the manufacturer.
12. Use only with the cart, stand, tripod, bracket, or table specified by the manufacturer, or sold with the apparatus. When a cart is used, use caution when moving the cart/apparatus combination to avoid injury from tip-over.
13. Unplug this apparatus during lightning storms or when unused for long periods of time.
14. Refer all servicing to qualified service personnel. Servicing is required when the apparatus has been damaged in any way, such as power-supply cord or plug is damaged, liquid has been spilled or objects have fallen into the apparatus, the apparatus has been exposed to rain or moisture, does not operate normally, or has been dropped.



Regulatory Compliance Notices

FCC Compliance Notice

This device complies with part 15 of FCC Rules. Operation is subject to the following two conditions: (1) this device may not cause harmful interference, and (2) this device must accept any interference received, including interference that may cause undesired operation.

This equipment has been tested and found to comply with the limits for a Class B digital device, pursuant to part 15 of the FCC Rules. These limits are designed to provide reasonable protection against harmful interference in a residential installation. This equipment generates, uses, and can radiate radio frequency energy, and if not installed and used in accordance with the instructions, may cause harmful interference to radio communications. However, there is no guarantee that interference will not occur in a particular installation. If this equipment does cause harmful interference to radio or television reception, which can be determined by turning the equipment off and on, the user is encouraged to try to correct the interference by one or more of the following measures:

- Reorient or relocate the receiving antenna.
- Increase the separation between the equipment and receiver.
- Connect the equipment into an outlet on a circuit different from that to which the receiver is connected.
- Consult the dealer or an experienced radio/TV technician for help.

Warning: You are cautioned that changes or modifications not expressly approved by the party responsible for compliance could void your authority to operate the equipment.

For Canada

- This Class B digital apparatus complies with Canadian ICES-003.
- Cet appareil numérique de la classe B est conforme à la norme NMB-003 du Canada.

Notes on the LCD Panel of This Display

- The Liquid Crystal Display (LCD) panel of this display has a very thin protective layer of glass which is liable to marking or scratching, and cracking if struck or pressured. The liquid crystal substrate is also liable to damage under excessive force or extreme temperatures. Please handle with care.
- The response time and brightness of the LCD panel may vary with the ambient temperature.
- Avoid placing the display in direct sun or where direct sun or spot lighting will shine onto the LCD panel, as the heat may damage the panel and the external casing of the display, and the bright light will make viewing the display more difficult than necessary.
- The LCD panel consists of individual pixels to display images and is manufactured according to the design specifications. While 99.9% of these pixels work normally, 0.01% of the pixels may remain constantly lit (in red, blue or green) or unlit. This is a technical limitation of the LCD technology and is not a defect.
- LCD screens, like plasma (PDP) and conventional CRT (Cathode Ray Tube) screens, are also susceptible to 'screen burn-in' or 'image retention' which can be found on the screen as visible fixed lines and shades. To avoid such damage to the screen, avoid displaying still images (like On-Screen Display menus, TV station logos, fixed/inactive text or icons) for more than two hours. Change the aspect ratio from time to time. Fill the entire screen with the image and eliminate the black bars whenever possible. Avoid displaying images in 4:3 aspect ratio over a long period of time, otherwise there may be visible burn marks on the screen as two vertical lines. Image retention issues are not covered under warranty, see standard warranty terms and conditions for details. For optimal performance, we suggest turning off the backlight power on the display for 8 hours per day.

Copyright

Copyright 2011. All rights reserved. No part of this publication may be reproduced, transmitted, transcribed, stored in a retrieval system or translated into any language or computer language, in any form or by any means, electronic, mechanical, magnetic, optical, chemical, manual or otherwise, without the prior written permission of the manufacturer.

Disclaimer

The manufacturer makes no representations or warranties, either expressed or implied, with respect to the contents of this document. The manufacturer reserves the right to revise this publication and to make changes from time to time in the contents thereof without obligation to notify any person of such revision or changes.

Package Contents

Open the sales package and check the contents. If any item is missing or damaged, please contact your dealer immediately.

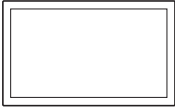

LCD display

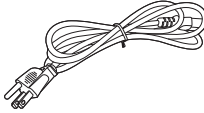

Power cord

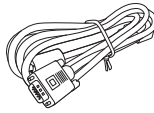

Mini D-Sub (15-pin)
cable

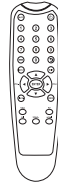

Remote control

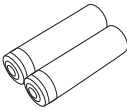

AAA batteries



Quick start guide

Notes:

- The type of power cord supplied may differ from that illustrated depending on your region of purchase.
- Before discarding the package, check that you haven't left any accessories inside the box.
- Dispose of packaging materials wisely. You can recycle the cardboard carton. Consider storing the package (if possible) for future transport of the display.
- Do not leave plastic bags within reach of young children or babies.

Parts of the Display and Their Functions

Front Panel

No.	Name	Description
1	Remote control sensor / Ambient light sensor / Power indicator	<ul style="list-style-type: none"> Receives command signals from the remote control. Detects ambient lighting conditions around the display and adjusts screen brightness automatically when the Ambient Light Sensor function is activated. Indicates the operating status of the display: <ul style="list-style-type: none"> Lights up green when the power is turned on. Lights up red when the display is turned off. Lights up red when the display is in Standby Eco mode. Flashes red when the display is in Standby Standard mode. Off when the main power is turned off.

Rear Panel

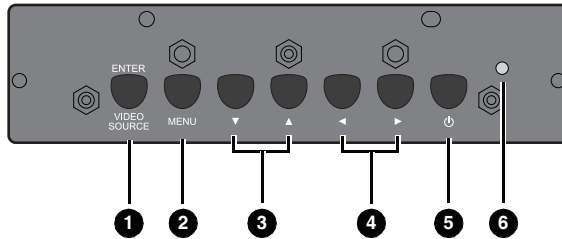

No.	Name	Description
1	ENTER/VIDEO SOURCE	<ul style="list-style-type: none"> Selects a video source. Confirms your selection or enters a submenu in the On-Screen Display (OSD) menu.
2	MENU	<ul style="list-style-type: none"> Opens the OSD menu. Returns to a previous menu or exits the OSD menu.
3	▼ / ▲	Scrolls through settings and options in the OSD menu.
4	◀ / ▶	Scrolls through settings and options in the OSD menu.
5	Power button	Turns on the display or puts it in standby mode.
6	Power indicator	<p>Indicates the power status of the display:</p> <ul style="list-style-type: none"> Lights up green when the power is turned on. Lights up red when the display is turned off. Lights up red when the display is in Standby Eco mode. Flashes red when the display is in Standby Standard mode. Off when the main power is turned off.

Input/Output Terminals

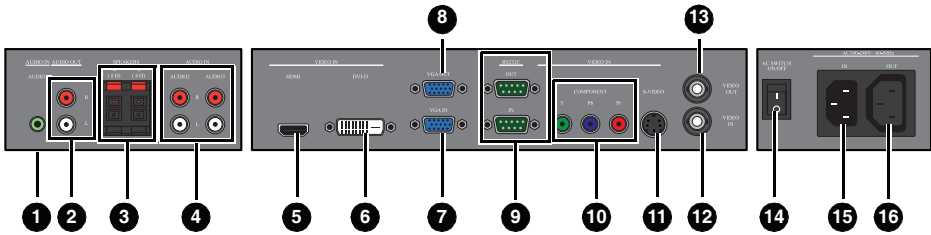

No.	Name	Description
1	AUDIO IN (AUDIO1)	Receives audio signals from an external device (such as a computer).
2	AUDIO OUT (L/R)	Outputs audio signals from an audio or HDMI input source to an external device.
3	SPEAKERS (L/R)	Outputs audio signals from an audio or HDMI input source to external speakers.
4	AUDIO IN (AUDIO2/AUDIO3)	Receives audio signals from an external device (such as a VCR or DVD player).
5	VIDEO IN (HDMI)	Receives HDMI signals from an external device (such as a Blu-ray disc player).
6	VIDEO IN (DVI-D)	Receives DVI signals from an external device (such as a computer).
7	VGA IN	Receives analog RGB signals from an external device (such as a computer).
8	VGA OUT	Outputs analog RGB signals from the VGA IN input to another display.
9	RS232C-IN/OUT	For external control and multi-display operation. <ul style="list-style-type: none"> • RS232C-IN: receives control signals from a computer or another display. • RS232C-OUT: outputs control signals from the RS232C-IN input to another display.
10	VIDEO IN (COMPONENT)	Receives component video (YPbPr) signals from an external device (such as a DVD player, HDTV device or Laser disc player).
11	VIDEO IN (S-VIDEO)	Receives S-Video signals from an external device (such as a VCR or DVD player).
12	VIDEO IN	Receives composite video signals from an external device (such as a VCR or DVD player).
13	VIDEO OUT	Outputs composite video signals from the VIDEO IN input to another display.
14	AC SWITCH ON/OFF	Turns on or off the main power.
15	AC IN	Connects to a power outlet via the supplied power cord.
16	AC OUT	Relays the AC power from the AC IN jack to another display.

Note:

Connector locations on the control panel may differ depending on the model.

Remote Control

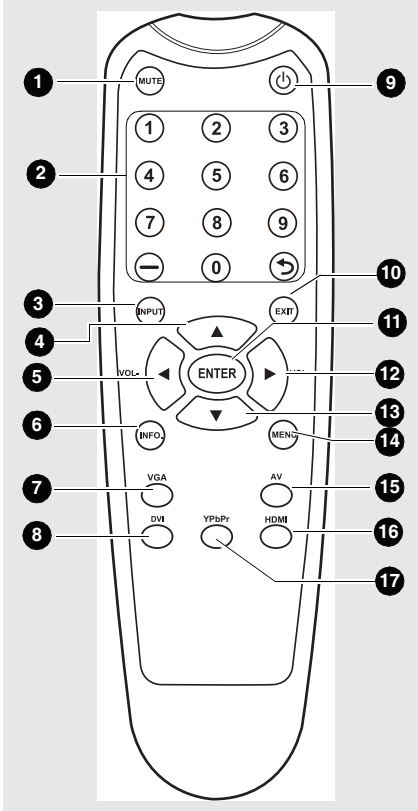

1 MUTE

Turns on or off the mute function.

2 Numeric buttons

No function.

3 INPUT

Selects an input source.

4 ▲

Scrolls through settings and options in the OSD menu.

5 ◀ / VOL-

- Scrolls through settings and options in the OSD menu.
- Turns down the volume.

6 INFO.

Shows the current input source and resolution.

7 VGA

Selects the VGA input source.

8 DVI

Selects the DVI input source.

9 Power

Turns on the display or puts it in standby mode.

10 EXIT

Returns to a previous menu or closes the OSD menu.

11 ENTER

Confirms your selection or save changes.

12 ▶ / VOL+

- Scrolls through settings and options in the OSD menu.
- Turns up the volume.

13 ▼

Scrolls through settings and options in the OSD menu.

14 MENU

Opens or closes the OSD menu.

15 AV

Selects the AV input source.

16 HDMI

Selects the HDMI input source.

17 YPbPr

Selects the YPbPr input source.

Using the Remote Control

Installing Remote Control Batteries

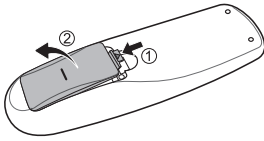

1. Open the remote control battery compartment cover.

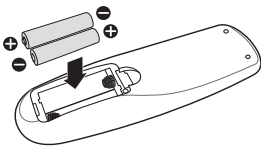

2. Insert the supplied batteries ensuring that the positive and negative marked battery terminals match the (+) and (-) marks in the battery compartment.

Note:

The supplied batteries are provided for your convenience so that you can operate the display straight away. You should replace them as soon as possible.

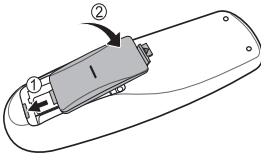

3. Refit the battery compartment cover.

Remote Control Usage Tips

- Point and aim the top front of the remote control directly at the display's remote control sensor window when you press the buttons.
- The remote control must be held at an angle within 45 degrees of the display's remote control sensor window to function correctly. The distance between the remote control and the sensors should not exceed 10 meters (32.8 feet).
- Do not let the remote control become wet or place it in humid environments (like bathrooms).
- If the display's remote control sensor window is exposed to direct sunlight or strong light, the remote control may not operate properly. In this situation, change the light source, readjust the angle of the display or operate the remote control from a location closer to display's remote control sensor window.

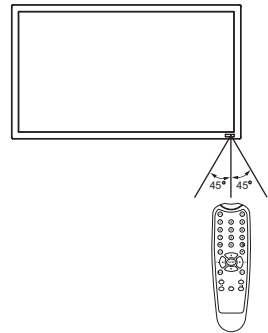

Battery Safety Notice

Using wrong types of batteries may cause chemical leaks and/or explosion. Please pay attention to the following notes:

- Always ensure that the batteries are inserted with the positive and negative terminals in the correct directions as shown in the battery compartment.
- Different types of batteries have different characteristics. Do not mix different types. Do not mix old and new batteries. Mixing old and new batteries will shorten battery life and/or cause chemical leaks from the old batteries.
- When batteries fail to function, replace them immediately.
- Chemical leaks from batteries may cause skin irritation. If any chemical matter seeps out of the batteries, wipe it up immediately with a dry cloth.

Setting Up the Display

Mounting the Display

You can install the display on a vertical surface with a suitable wall mounting bracket or on a horizontal surface with the optional desktop stands. Please pay attention to the following notes during installation:

- This display should be installed by at least two adult persons. Attempting to install this display by only one person may result in danger and injuries.
- Refer the installation to qualified technicians. Improper installation may cause the display to fall or malfunction.

VESA mounts are used to secure the PS-Series for display. The PS-Series displays can be installed using a variety of VESA mounts available through Planar. If you do not have a VESA mount and would like to purchase one, contact Planar.

If you purchased a VESA mount, you should have received a separate box with mounting supplies and an installation manual. Follow these instructions carefully.

Keep in mind the following general installation guidelines:

- Screw length is crucial and will vary depending on the type of mount you use. Total screw length will include the penetration length plus the length required by the type of VESA mount in use.

Caution: Shorter screws will result in insufficient mounting length and longer screws could puncture parts inside the display.

- Prior to installation, make sure you know where all of the mounting points are located.
- Follow all safety precautions outlined in the VESA Installation manual.
- Verify the parts received with the list shown in the VESA Installation manual.

Notes:

- To maintain proper ventilation, keep at least 10mm of clear space from wall to rear cover of the display.
- The power connector should be positioned at the bottom of other connectors when you rotate the display.
- Please consult a professional technician for wall mount installations. The manufacturer accepts no liability for installations not performed by a professional technician.

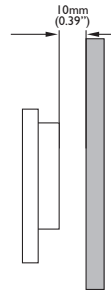

Connecting Audio/Video Signals

Pay attention to the following notes when you connect cables:

- Please turn off all devices.
- Familiarize yourself with the audio/video ports on the display and the devices you want to use. Be aware that incorrect connections may adversely affect picture quality.
- Do not remove cables from the ports by pulling the cable itself. Always grasp and pull the connectors at the end of the cable.
- Ensure that all cables are fully inserted and firmly seated.

Connecting the VGA Input

1. Connect the VGA IN jack on the display to the VGA output jack on a computer using a Mini D-Sub (15-pin) cable.
2. Connect the computer's audio output jack to the AUDIO IN jack on the display using a suitable audio cable.
3. If a second display is used, connect the VGA OUT jack on the first display to the VGA IN jack on the second display using a Mini D-Sub (15-pin) cable. This relays the VGA input signal from the first display to the second one.
4. To view images from this input, press the VGA button on the remote control.

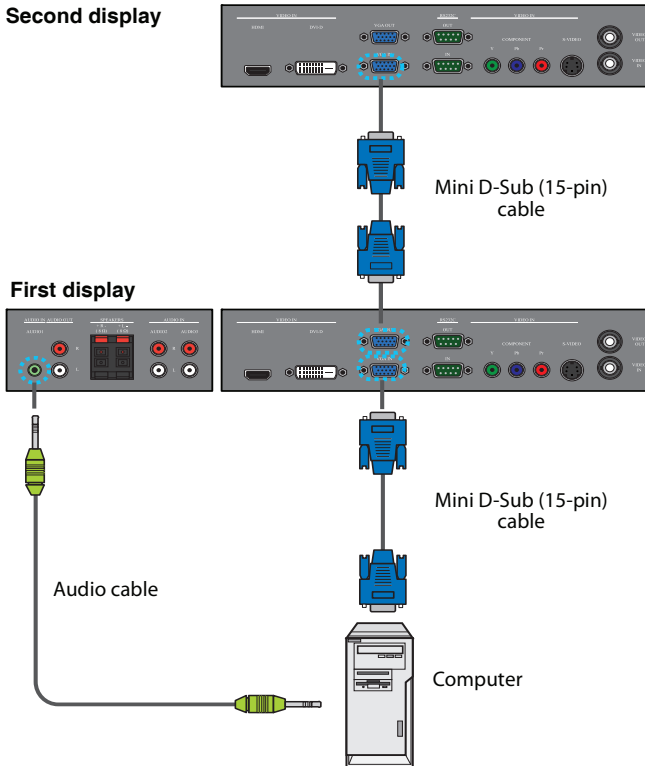

*The audio cable is not supplied and should be purchased separately.

Note:

Connector locations on the control panel may differ depending on the model.

Connecting the Digital Input

1. Connect the VIDEO IN (DVI-D) jack on the display to the DVI-D output jack on a computer using a DVI-D cable. If the computer has an HDMI output jack, connect the computer's HDMI output jack to the VIDEO IN (HDMI) input jack on the display using an HDMI cable or a DVI-D to HDMI conversion cable.
2. Connect the computer's audio output jack to the AUDIO IN jack on the display using a suitable audio cable.
3. To view video image from this input, press the DVI or HDMI button on the remote control.

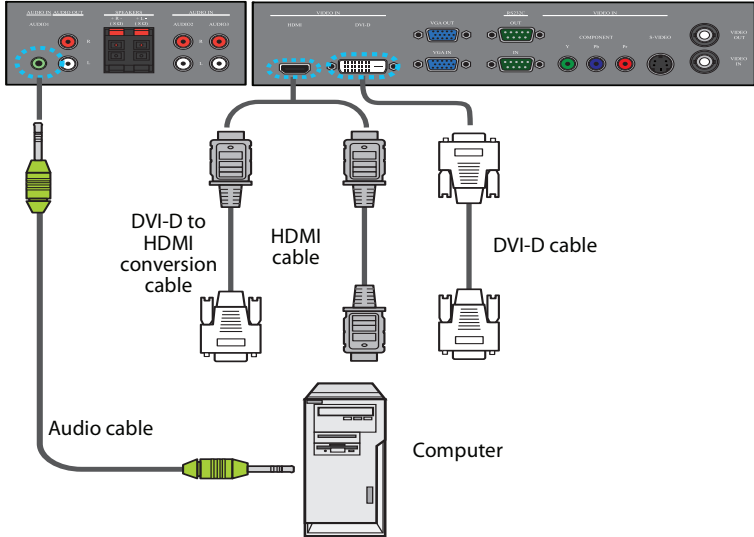

*The cables are not supplied and should be purchased separately.

Note:

Connector locations on the control panel may differ depending on the model.

Connecting the YPbPr Component Video Input

1. Connect the VIDEO IN (COMPONENT) jacks on the display to the component output jacks on an A/V device (such as a VCR or DVD player) using a component video cable.
2. Connect the DVD player's audio output jacks to the AUDIO IN (AUDIO2 or AUDIO3) jacks on the display using a suitable audio cable.
3. To view video image from this input, press the YPbPr button on the remote control.

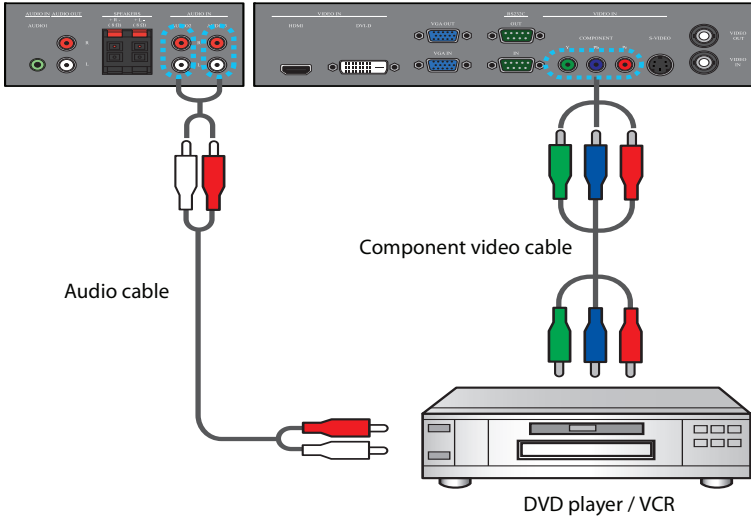

*The cables are not supplied and should be purchased separately.

Note:

Connector locations on the control panel may differ depending on the model.

Connecting the AV and S-Video Inputs

1. Connect the VIDEO IN (S-VIDEO) or VIDEO IN jack on the display to the output jack on an A/V device (such as a VCR) using an appropriate video cable.
2. Connect the VCR's audio output jacks to the AUDIO IN (AUDIO2 or AUDIO3) jacks on the display using a suitable audio cable.
3. If a second display is used, connect the VIDEO-OUT jack on the first display to the VIDEO IN jack on the second display using an AV cable. This relays the input signal from the first display to the second one.
4. To view video image from this input, press the AV button on the remote control for the AV signal, or press the INPUT button repeatedly for the S-Video signal.

Second display

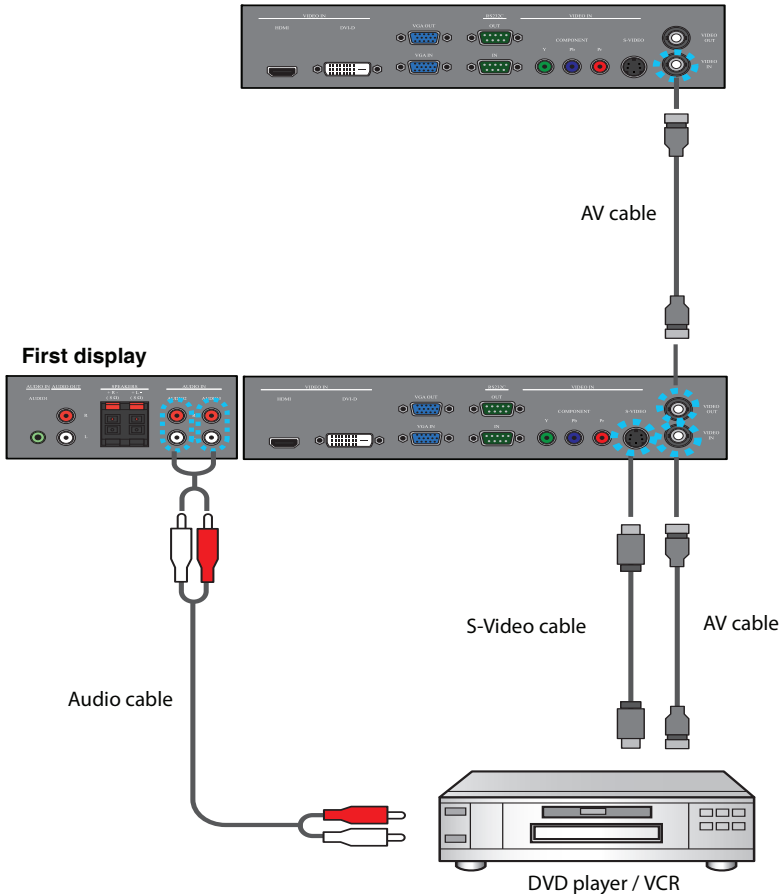

*The cables are not supplied and should be purchased separately.

Note:

Connector locations on the control panel may differ depending on the model.

Connecting External Speakers

The built-in amplifier on the display allows you to output audio signals through external speakers. Connect external speakers to the SPEAKERS jacks on the display.

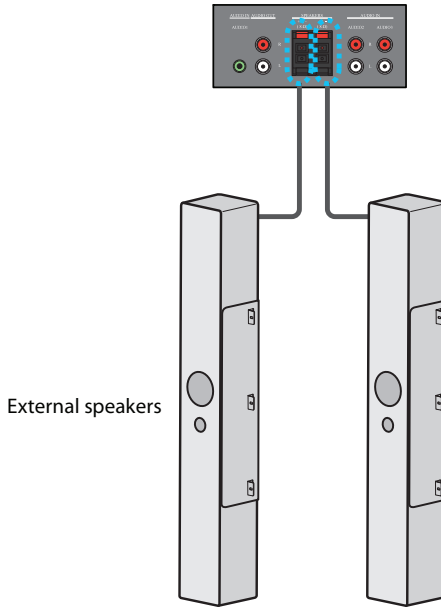

Note:

You can use the remote control or the control panel on the display to adjust the volume.

Connecting Multiple Displays

With the RS232C-IN/OUT interfaces, you can connect multiple displays serially (daisy chain) to a computer for management. The number of displays you can connect serially depends on the resolution of the input signal you use.

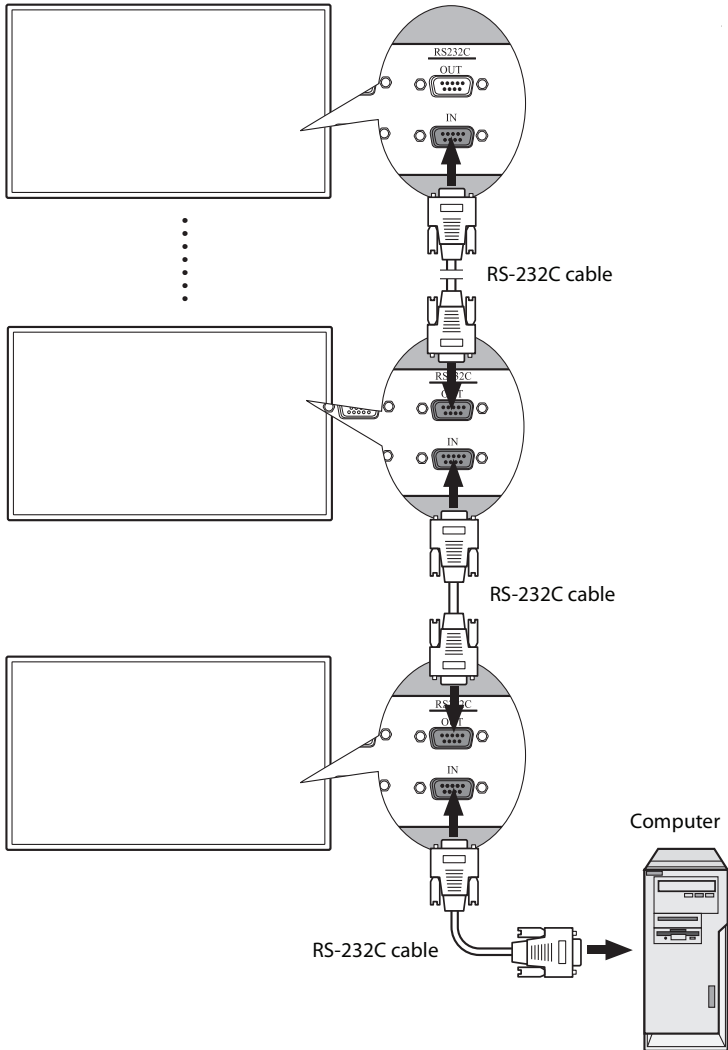

Note:

This function requires an RS-232C port equipped computer with the display management software installed.

Connecting the Touch Module

Connect the USB cable on the display to a computer.

The touch module supports easy Plug-and-Play operations. There is no need to install additional drivers on the computer.

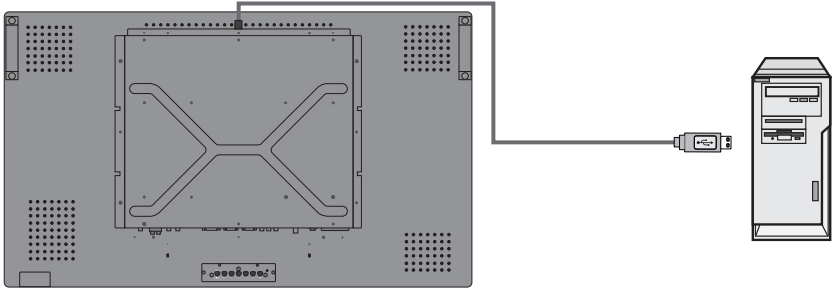

Connecting Power

1. Plug one end of the power cord into the AC IN jack on the display and the other end into an appropriate power outlet (if the outlet is switched, turn on the switch).
2. Press the power switch to turn on the main power. The display will enter standby mode and the power indicator will light up amber.

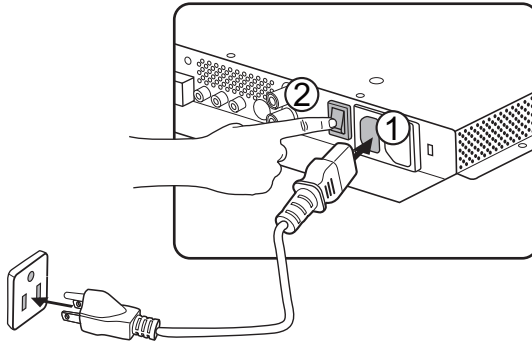

Notes:



- The supplied power cord is suitable for use with 110-240V AC power only.
- The power cord and outlet illustrated may differ from the ones used in your region.
- Only use an appropriate power cord for your region. Never use a power cord which appears damaged or frayed, or change the plug type on the power cord.
- Be aware of the power loading when you use extension cords or multiple outlet power boards.
- There are no user serviceable parts in this display. Never unscrew or remove any covers. There are dangerous voltages inside the display. Turn off the power and unplug the power cord if you intend to move the display.

Using the Touch Screen

You can use the optical touch screen to control your operating system. The touch screen can emulate basic mouse functions and supports multi-touch functions for Windows 7*. The following table shows a list of gestures you can use on the touch screen.

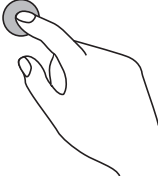
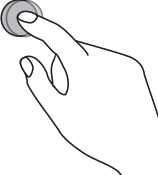
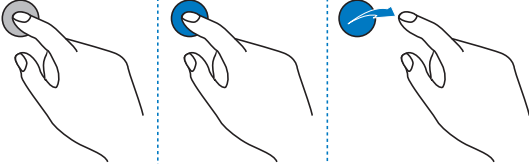
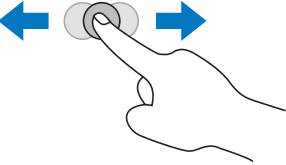
Note: Ensure that you have installed the USB cable on the display to a computer.
***Multi-touch functions are only supported by Windows 7 - Home Premium, Professional, Enterprise and Ultimate versions. For Windows XP, Windows Vista and Windows 7 - Starter and Home Basic versions, multi-touch is not supported.**

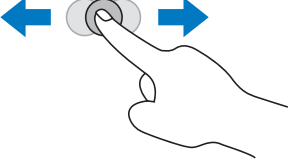
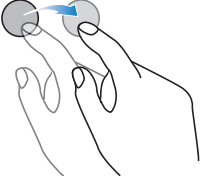
OS functions	Gesture actions
For Windows XP, Windows Vista and Windows 7	
Click	Tap the screen once. 
Double-click	Tap the screen twice. 
Right-click	<ol style="list-style-type: none"> 1. Press on the target. 2. Hold and wait for a blue ring to appear. 3. Release your finger. 
Drag	Drag one finger left or right. 

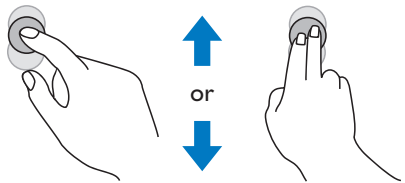
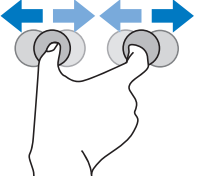
OS functions	Gesture actions
For Windows Vista and Windows 7	
Selection	<p>Drag one finger left or right.</p> 
Pan up / Pan down / Back / Forward	<p>Quickly drag your finger (Flick) in a desired direction.</p> 
Multi-touch functions For Windows 7 - Home Premium, Professional, Enterprise and Ultimate versions	
Right-click	<ol style="list-style-type: none"> 1. Press on the target. 2. Tap the screen with another finger. 3. Release the second finger. 
Scrolling	<p>Drag one or two fingers up or down.</p> 
Zoom	<p>Move two fingers apart or toward each other.</p> 

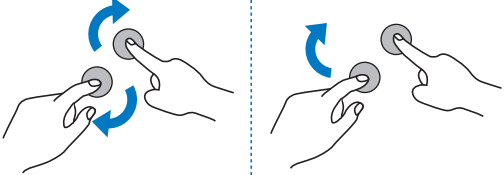
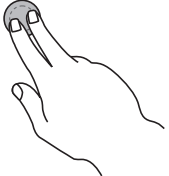
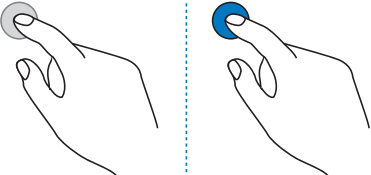
OS functions	Gesture actions
<p>Supported by specific applications</p>	<ul style="list-style-type: none"> • Move two fingers in opposing directions. • Use one finger to pivot around another. 
<p>Supported by specific applications</p>	<p>Tap two fingers simultaneously. The target should be the midpoint between the fingers.</p> 
<p>For Windows XP, Windows Vista and Windows 7</p>	
<p>Wakeup from Windows sleep mode (S3)</p>	<p>Press and hold for 4 seconds.</p> 

Calibrating the Touch Screen

- The function described in this section only applies to Windows 7 - Home Premium, Professional, Enterprise and Ultimate versions.
- Ensure that you have installed the USB cable on the display to a computer.

You can calibrate the touch screen to use it more efficiently.

To adjust calibration:

1. In Windows, tap the **Start** button and then **Control Panel**. In the search box, type **Tablet PC Settings** and tap **Tablet PC Settings** from the result list.
2. On the **Display** tab, under **Display Options**, tap **Calibrate**. If you are prompted for an administrator password or confirmation, type the password or provide confirmation.
3. Follow the instructions on the screen and tap **Yes** to save your calibration settings.

Important Instructions for Using the Touch Screen

- You can calibrate the touch screen using the Windows 7 calibration routine.
- Do not bend the retro-reflective bars. The touch screen cannot function normally if the bars are bent.
- Keep the touch screen out of direct sunlight or spotlights.
- Avoid displaying still images to prevent image retention.
- Regularly clean the retro-reflective bars with a clean, soft cloth. A dusty environment may adversely affect the performance of your touch screen. Clean the retro-reflective bars as illustrated below. Do not clean the touch sensors on the top of the screen.

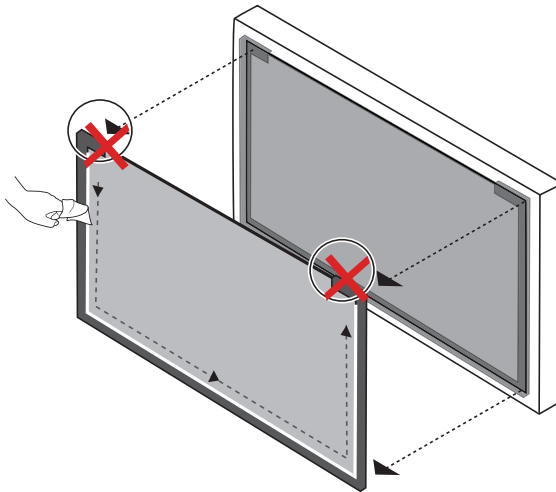

Note: Windows is a registered trademark of Microsoft Corporation in the United States and other countries.

Basic Operations

Turning the Display On or Off

To turn on or off the display, press the power button on the display's control panel or on the remote control.

Notes:

- The display's standby mode still consumes a very small amount of power. To completely cut off the power supply, press the power switch to turn off the main power.
- The display follows the VESA approved DPM Power Management function. The power management function is an energy saving feature that automatically reduces the display's power consumption when the keyboard or the mouse has not been used for a fixed period.

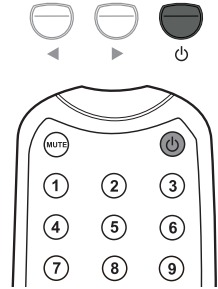

Locking/Unlocking the Controls

The display's controls can be locked and unlocked to prevent unwanted or accidental operations. These commands are used for locking and unlocking.

Control Panel Buttons

Press and hold ◀ and ▶ simultaneously for 5 seconds. Once locked, the control panel buttons do not function unless unlocked.

OSD Menu Function

Press and hold ▲ and ▼ simultaneously for 5 seconds. Once locked, the MENU button on the control panel does not function, and the OSD menu can not be used unless unlocked.

Power On/Off Function

Press and hold MENU and ◀ for 5 seconds. Once locked, the power button on the control panel does not function, and current power on/off status will be kept unless unlocked.

Remote Control Functions

Press and hold MENU and ▶ for 5 seconds. Once locked, the display does not respond to any remote control operations unless unlocked.

Switching Input Signals

Press the VGA, DVI, HDMI, YPbPr, AV and INPUT buttons on the remote control or the INPUT button on the control panel to select an input signal.

Adjusting Audio Volume Level

Press ▲/▼ on the control panel or VOL+/VOL- on the remote control to adjust the volume.

The OSD (On-Screen Display) Menu







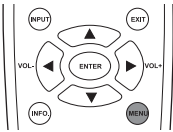

OSD Menu Overview

Menu name	Options/functions	See page
Picture	<ul style="list-style-type: none">• Picture Mode• Contrast• Brightness• Color• Tint• Sharpness• Backlight• DCR• Color Temp• Input Resolution	25
Sound	<ul style="list-style-type: none">• Volume• Mute• Audio Source• Speaker	26
Option	<ul style="list-style-type: none">• Aspect ratio• PIP• Video Source• Auto Adjustment• Clock Frequency• Phase• H Position• V Position• Ambient Light Sensor• Auto Detection• Touch Feature	27
Setting	<ul style="list-style-type: none">• Language• Overscan• Schedule• Display Wall• Power Save• Set Monitor ID• Image Retention• Auto Adjustment• Advanced	28

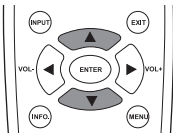
Note:

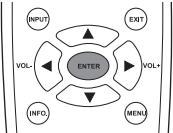
Some options are only available when a certain input signal source is selected.

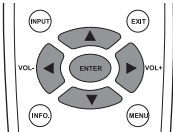
Operations in the OSD Menu

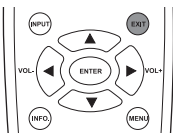
Using the control panel buttons	Using the remote control
<p>1. Press MENU to open the OSD menu.</p>  <p>The diagram shows a row of seven buttons: ENTER, MENU, a downward arrow, an upward arrow, a leftward arrow, a rightward arrow, and a power button. A hand is pointing to the MENU button. The labels 'ENTER' and 'VIDEO SOURCE' are positioned to the left of the first two buttons.</p>	<p>1. Press MENU to open the OSD menu.</p>  <p>The diagram shows a remote control with buttons for INPUT, EXIT, VOL-, VOL+, ENTER, INFO, and MENU. The MENU button is highlighted with a grey circle.</p>
<p>2. Press ▲ or ▼ to select an item.</p>  <p>The diagram shows the same row of seven buttons as in step 1. Two hands are pointing to the upward and downward arrow buttons. The labels 'ENTER' and 'VIDEO SOURCE' are positioned to the left of the first two buttons.</p>	<p>2. Press ▲ or ▼ to select an item.</p>  <p>The diagram shows the same remote control as in step 1. The upward and downward arrow buttons are highlighted with grey circles.</p>
<p>3. Press ENTER/VIDEO SOURCE to confirm selections.</p>  <p>The diagram shows the same row of seven buttons. A hand is pointing to the ENTER button. The labels 'ENTER' and 'VIDEO SOURCE' are positioned to the left of the first two buttons.</p>	<p>3. Press ENTER to confirm selections.</p>  <p>The diagram shows the same remote control. The ENTER button is highlighted with a grey circle.</p>
<p>4. Press ▲ or ▼ to select a feature and press ◀ or ▶ to adjust settings. Press ENTER/VIDEO SOURCE to save changes.</p>  <p>The diagram shows the same row of seven buttons. Four hands are pointing to the upward, downward, leftward, and rightward arrow buttons. The labels 'ENTER' and 'VIDEO SOURCE' are positioned to the left of the first two buttons.</p>	<p>4. Press ▲ and ▼ to select a feature and press ◀ or ▶ to adjust settings. Press ENTER to confirm changes.</p>  <p>The diagram shows the same remote control. The upward, downward, leftward, and rightward arrow buttons are highlighted with grey circles.</p>
<p>5. Press MENU to close the OSD menu.</p>  <p>The diagram shows the same row of seven buttons. A hand is pointing to the MENU button. The labels 'ENTER' and 'VIDEO SOURCE' are positioned to the left of the first two buttons.</p>	<p>5. Press EXIT to close the OSD menu.</p>  <p>The diagram shows the same remote control. The EXIT button is highlighted with a grey circle.</p>

Picture Menu

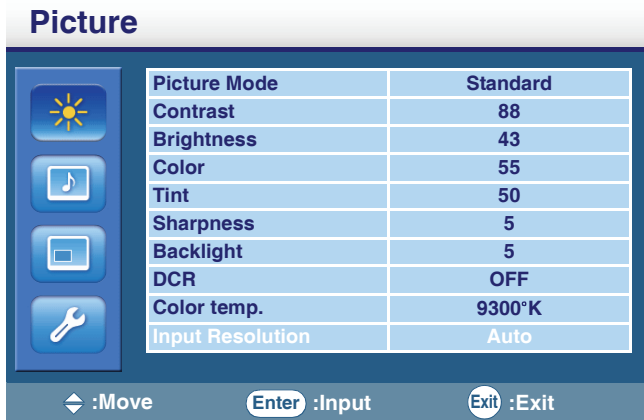

Name	Description
Picture Mode	Sets the display mode.
Contrast	Adjusts the image contrast when Picture Mode is set to User.
Brightness	Adjusts the image brightness when Picture Mode is set to User.
Color	Adjusts the color intensity when Picture Mode is set to User.
Tint	Adjusts the color tint when Picture Mode is set to User.
Sharpness	Adjusts the image sharpness when Picture Mode is set to User.
Backlight	Adjusts the backlight intensity for the screen. Note: This feature is not available if the Ambient Light Sensor function is set to HIGH or LOW.
DCR	Turns the DCR function on or off. This feature enhances image contrast for dark scenes. Note: This feature is not available if the Ambient Light Sensor function is set to HIGH or LOW.
Color Temp	Adjusts the color temperature.
Input Resolution	Sets the VGA input resolution. This is only required when the display cannot detect the resolution correctly.

Adjusting the Contrast

1. Set the contrast to the highest level.
2. Gradually decrease the contrast level until you reach the point where the details in the bright areas of the image can be seen clearly. Do not further decrease the contrast level to avoid losing the saturation of colors.

Adjusting the Brightness

1. Set the brightness to the lowest level.
2. Gradually increase the brightness level until you reach the point where the details in the dark areas of the image can be seen clearly. Do not further increase the brightness level to avoid the black areas from looking grayish.

Sound Menu

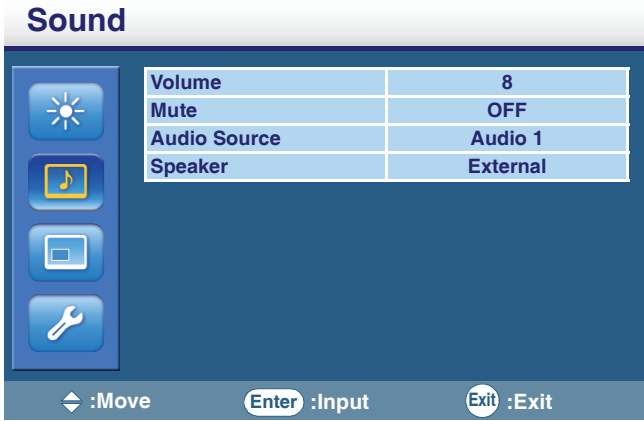

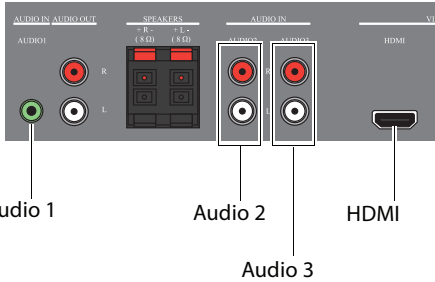
Name	Description
Volume	Adjusts the volume.
Mute	Turns the mute function on or off.
Audio Source	<p>Sets the audio input source.</p> 
Speaker	<p>Sets the audio source.</p> <ul style="list-style-type: none"> • External: Selects the audio output source from SPEAKERS on the rear connector panel. • Line-Out: Selects the audio output source from AUDIO OUT on the rear connector panel. • Internal: Select the audio input source from AUDIO IN on the rear connector panel. (PS4200 only)

Option Menu

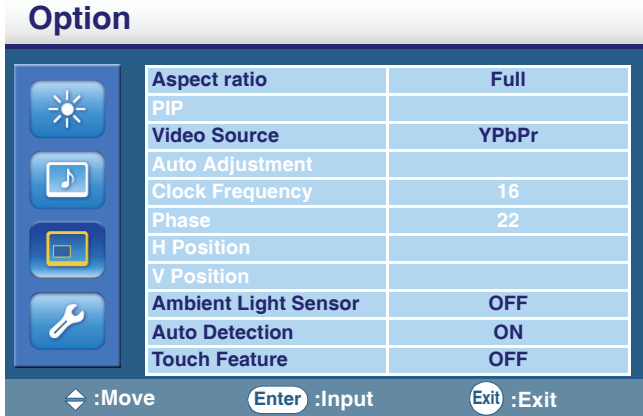

Name	Description
Aspect ratio	Displays the input image in its original aspect ratio (when Original is selected) or forces the display to fill the input image on the entire display area (when Full is selected).
PIP (Picture in Picture)	<ul style="list-style-type: none"> • ON/OFF: Turns on or off the PIP function. • Main Input: Sets an input source for the main picture. • Sub Input: Sets an input source for the sub picture. • PIP Size: Changes the size of the sub picture. • PIP Position: Changes the position of the sub picture. <p>Notes:</p> <ul style="list-style-type: none"> • This feature is not available for AV and S-Video inputs. • PIP is not available for all signal source combinations. See "Supported PIP Input Signal Combination" on page 32 for more information on supported combinations. • In PIP mode, only sounds from the Main Input picture will be available.
Video Source	Sets the video input source.
Auto Adjustment	Automatically optimizes image display for the VGA input.
Clock Frequency	Adjusts the clock frequency of the VGA or YPbPr input image.
Phase	Adjusts the phase of the VGA or YPbPr input image.
H Position	Adjusts the horizontal position of the VGA input image.
V Position	Adjusts the vertical position of the VGA input image.
Ambient Light Sensor	Adjusts the ambient light sensitivity around the display.
Auto Detection	Automatically detects available input sources.
Touch Feature	<p>When turned on, Input Resolution, Aspect ratio, PIP, Clock Frequency, Phase, H Position, V Position, Overscan and Display Wall will be disabled to optimize touch performance.</p> <p>Note: This feature is only available for VGA, DVI and HDMI inputs.</p>

Note: The adjustment of the Clock Frequency, Phase, H Position and V Position settings is only required when the Auto Adjustment function does not work perfectly on certain input signals.

Setting Menu

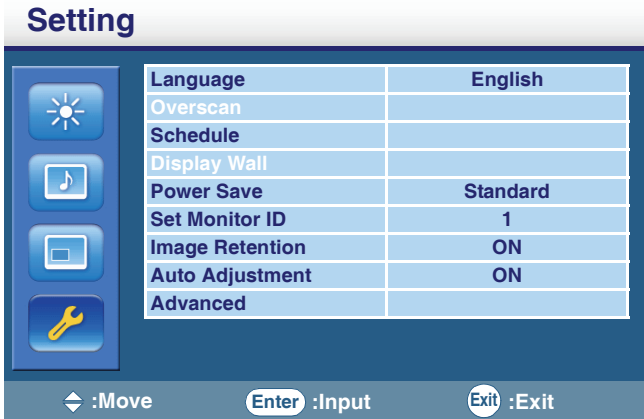

Name	Description
Language	Sets your preferred language for the OSD menu.
Overscan	Turns the HDMI overscan function on or off.
Schedule	<ul style="list-style-type: none"> • Date and Time: Sets the current date and time. • Schedule: Sets when to turn on or off the display and which input source should be used for each schedule. <p>Notes:</p> <ul style="list-style-type: none"> • Set the current time before you set the Schedule. • When schedule settings overlap, the Every Day setting takes priority over other weekly settings. • When schedule settings overlap, scheduled power-on time takes priority over scheduled power-off time. • If two schedules have the same settings, the first schedule on the list will take priority.
Display Wall	<ul style="list-style-type: none"> • H Monitors: Sets the number of displays used in the horizontal position. • V Monitors: Sets the number of displays used in the vertical position. • H Position: Sets the horizontal position of the display wall matrix. • V Position: Sets the vertical position of the display wall matrix. • Frame Comp.: Adjusts images near the display edges for optimal demonstration across the display wall.
Power Save	<p>Sets the display to enter the power saving mode when there is no signal detected.</p> <ul style="list-style-type: none"> • Eco: All source can enter the power saving mode, but only a VGA signal can wake up the display or you have to press the power button to wake up the display when other source is connected. • Standard: All source can enter the power saving mode and wake up the display. • Off: If no source is detected, the backlight will continue on. • VGA Only: Only the VGA signal can enter the power saving mode and wake up the display. <p>Note: Serial can bring any mode out of the power savings.</p>
Set Monitor ID	Assigns an ID number for the current display when multiple displays are connected.

Image Retention	Automatically displays swift moving patterns every 10 seconds to prevent image retention on the screen.
Auto Adjustment	Automatically optimizes image display for the VGA input.
Advanced	<ul style="list-style-type: none">• Reset User Default: Resets all OSD settings (except the Language setting) to the factory settings.• OSD Info Box: When turned ON, the display will always show the current input source and resolution onscreen. Select OFF to show the information box onscreen only when you press INFO. on the remote control.• Status<ul style="list-style-type: none">• Thermal: Shows current temperature inside the display.• Ambient Light: Shows current ambient brightness around the display.• 5V Detect: Shows the current 5V voltage detection result.• 12V Detect: Shows the current 12V voltage detection result.• Operating Time: Shows the time elapsed since the display was last turned on. D=Day, H=Hour.• FW Version: Shows the current firmware version.• Input Source: Shows the current input source and its resolution.

Product Information

Specifications

Item	Specifications	
Model	PS4200TL	
LCD panel	Active area (H x V) (mm)	930.24 x 523.26
	Pixel pitch (mm)	0.4845
	Native resolution (pixels)	1920 x 1080
	Brightness (cd/m ²)	500 (typical)
	Contrast	1500:1 (typical)
	Response time (ms)	5 (typical)
Touch	Technology	Optical Dual Touches (for Win 7 only)
	Resolution (points area function)	32767 x 32767
	Capacity	2 simultaneous touches
	Accuracy	+/- 3 mm over 95% touchable area
	Touch Output	USB 2.0
	PC	Support Windows XP/Vista/7
Glass	Tempered glass	3.8 mm + 0 mm/-0.3 mm
Input	Computer	VGA (Mini D-Sub 15-pin), DVI (DVI-D)
	Video	Composite Video (BNC jacks), S-Video, Y Pb Pr (RCA jacks), HDMI
	Audio	L/R (RCA jacks), Line-in (3.5 mm Mini-jack)
	Control	RS-232C (Mini D-Sub 9-pin)
Output	Computer	VGA (Mini D-Sub 15-pin)
	Video	Composite Video (BNC jacks)
	Speaker	External speaker jack (12W+12W, 8 Ohms)
	Audio	L/R (RCA jacks)
	Control	RS-232C (Mini D-Sub 9-pin)
Audio	Audio W (Amp)	12W
	Internal speaker	No
Power	Supply	100 - 240V AC, 50/60 Hz
	Consumption Max.	< 210W
	Consumption Standby	< 0.5W
Environment	Display Orientation	Landscape
	Operating Temperature	0 - 40°C, 32 - 104°F
	Operating Humidity	10 - 90% RH Non-Condensing
	Storage Temperature	-20 - 60°C, 4 - 140°F
	Storage Humidity	10 - 95% RH Non-Condensing
Mechanical	Weight (lbs/kg)	67.2/30.5 (Approximately)
	Dimensions	39.1 x 23.0 x 5.1/992 x 585 x 128.9
	(W x H x D) (inch/mm)	

Note:

Specifications and functions are subject to change without notice.

Supported Input Signal Resolution

Resolution	Input source					
	AV	S-Video	YPbPr	VGA	HDMI	DVI
640 x 480 @ 60Hz				○	○	○
640 x 480 @ 72Hz				○	○	○
640 x 480 @ 75Hz				○	○	○
720 x 400 @ 70Hz				○	○	○
800 x 600 @ 60Hz				○	○	○
800 x 600 @ 75Hz				○	○	○
1024 x 768 @ 60Hz				○	○	○
1024 x 768 @ 75Hz				○	○	○
1280 x 768 @ 60Hz				○	○	○
1280 x 960 @ 60Hz				○	○	○
1280 x 1024 @ 60Hz				○	○	○
1360 x 768 @ 60Hz				○	○	○
1366 x 768 @ 60Hz				○	○	○
1600 x 1200 @ 60Hz				○	○	○
1920 x 1080 @ 60Hz				○	○	○
576i (50Hz)	○	○	○		○	
480i (60Hz)	○	○	○		○	
480p (60Hz)			○		○	
576p (50Hz)			○		○	
720p (50Hz)			○		○	
720p (60Hz)			○		○	
1080i (50Hz)			○		○	
1080i (60Hz)			○		○	
1080p (50Hz)			○		○	
1080p (60Hz)			○		○	

Note:

- ○: supported
- Blank: not supported

Supported PIP Input Signal Combination

		Main picture signal source					
		AV	S-Video	VGA	YPbPr	DVI	HDMI
Sub picture signal source	AV	×	×	×	×	×	×
	S-Video	×	×	×	×	×	×
	VGA	×	×	×	×	○	○
	YPbPr	×	×	×	×	○	○
	DVI	×	×	○	○	×	×
	HDMI	×	×	○	○	×	×

		Main picture									
		HDMI									
		1080p (60Hz)	1080p (50Hz)	1080i (60Hz)	1080i (50Hz)	720p (60Hz)	720p (50Hz)	576p (50Hz)	480p (60Hz)	480i (60Hz)	576i (50Hz)
Sub picture											
VGA	640 x 480 @ 60Hz					○	○	○	○	○	○
	640 x 480 @ 72Hz					○	○	○	○	○	○
	640 x 480 @ 75Hz					○	○	○	○	○	○
	720 x 400 @ 70Hz					○	○	○	○	○	○
	800 x 600 @ 60Hz					○	○	○	○	○	○
	800 x 600 @ 75Hz					○	○	○	○	○	○
	1024 x 768 @ 60Hz					○	○	○	○	○	○
	1024 x 768 @ 75Hz					○	○	○	○	○	○
	1280 x 768 @ 60Hz					○	○	○	○	○	○
	1280 x 960 @ 60Hz					○	○	○	○	○	○
	1280 x 1024 @ 60Hz					○	○	○	○	○	○
	1360 x 768 @ 60Hz					○	○	○	○	○	○
	1366 x 768 @ 60Hz					○	○	○	○	○	○
	1600 x 1200 @ 60Hz					○	○	○	○	○	○
1920 x 1080 @ 60Hz					○	○	○	○	○	○	

Troubleshooting

Problem	Solution
No picture	<p>Check the following:</p> <ul style="list-style-type: none"> • Is the display turned on? Check the power indicator of the display. • Is the signal source device turned on? Turn on the device and try again. • Are there any loose cable connections? Make sure that all cables are connected firmly. • Have you chosen an unsupported output resolution on the computer? Refer to "Supported Input Signal Resolution" on page 31 to select a supported resolution and try again. • Have you chosen an unsupported output resolution on the DVD or Blu-ray disc player? Refer to "Supported Input Signal Resolution" on page 31 to select a supported resolution and try again.
No sound	<p>Check the following:</p> <ul style="list-style-type: none"> • Have you turned on the mute function on the display or the input source device? Turn off the mute function or increase the audio volume level and try again. • Are there any loose cable connections? Make sure that all cables are connected firmly.
The computer input image looks strange	<ul style="list-style-type: none"> • Have you chosen an unsupported output resolution on the computer? Refer to "Supported Input Signal Resolution" on page 31 to select a supported resolution and try again. • Use the Auto Adjustment function (See "Auto Adjustment" on page 27) to let the display automatically optimize the display of computer image. • If the result of the Auto Adjustment function is not satisfactory, use the Clock Frequency, Phase, H Position and V Position functions to manually adjust the image.
The control panel buttons do not work	<p>Have you locked the control panel buttons? Unlock the buttons and try again.</p>
The remote control does not work	<ul style="list-style-type: none"> • Have you locked the remote control function? Unlock the function and try again. • Check for incorrect battery orientation. • Check for dead batteries. • Check your distance and angle from the display. • Check whether remote control is properly being pointed at the display's remote control sensor window. • Check for any obstacle between the remote control and the remote control sensor window. • Check that the remote control sensor window is not under strong fluorescent lighting. or in direct sunlight. • Check for any devices (computer or personal digital assistant, PDA) nearby that transmit infrared signals which may cause interference to signal transmission between the remote control and the display. Turn off the infrared function of these devices.

Planar Systems, Inc.
Customer Service
24x7 Online Technical Support: <http://www.planar.com/support>

Americas Support
Tel: 1-866-PLANAR1 (866-752-6271) or +1 503-748-1100
Hours: M-F, 9am - 7pm Eastern Time | M-F, 6am - 4pm Pacific Time

Europe and Asia-Pacific Support
Tel: +358-9-420-01
Hours: M-F, 7:00am - 4pm CET

© 2011 Planar Systems, Inc. 05/08 Planar is a registered trademark of Planar Systems, Inc.
Other brands and names are the property of their respective owners.
Technical information in this document is subject to change without notice.

Document No. 020-1146-00 Rev. A.