

PLANAR®

PLANAR LCD MONITOR PT170MU MANUAL

[www.planar.com](http://www.planar.com)

---

# *Table of Contents*

---

## **Usage Notice**

<i>Precautions</i> .....	2
--------------------------	---

## **Introduction**

<i>About the Product</i> .....	3
<i>Package Overview</i> .....	4

## **Installation**

<i>Product Overview</i> .....	5
<i>Start Your Installation</i> .....	8

## **User Controls**

<i>Front Panel Controls</i> .....	10
<i>How to Use the OSD Menus</i> .....	11
<i>On-Screen Display Menus</i> .....	12

## **Appendix**

<i>Troubleshooting</i> .....	16
<i>Warning Signal</i> .....	17
<i>Product Dimensions</i> .....	18
<i>Compatibility Modes</i> .....	19
<i>Touch Screen Driver Installation</i> .....	20

## *Usage Notice*

---



**Warning-** To prevent the risk of fire or shock hazards, do not expose this product to rain or moisture.



**Warning-** Please do not open or disassemble the product as this may cause electric shock.

### **Precautions**

*Follow all warnings, precautions and maintenance as recommended in this user's manual to maximize the life of your unit.*

#### **Do:**

- Turn off the product before cleaning.
- Use only a dry soft cloth or clean room wiper when cleaning the LCD panel surface.
- Use a soft cloth moistened with mild detergent to clean the display housing.
- Use only high quality and safety approved AC/DC power adapter.
- Disconnect the power plug from AC outlet if the product is not used for a long period of time.

#### **Don't:**

- Do not touch the LCD panel surface with sharp or hard objects.
- Do not use abrasive cleaners, waxes or solvents for your cleaning.
- Do not operate the product under the following conditions:
  - Extremely hot, cold or humid environment.
  - Areas susceptible to excessive dust and dirt.
  - Near any appliance generating a strong magnetic field.
  - Place in direct sunlight.

---

# ***Introduction***

---

## **About the Product**

Having a 17" flat panel screen with an active matrix, thin-film transistor (TFT) liquid crystal display (LCD) , this product also demonstrates following outstanding features.

- ❑ Analog signal input
- ❑ Active matrix TFT LCD technology
- ❑ 1280 x 1024 addressable pixels
- ❑ 17" diagonal screen size
- ❑ 31.5 ~ 80 kHz horizontal scan
- ❑ 56 ~ 75 Hz refresh rate
- ❑ VESA wall mountable
- ❑ Auto-adjustment
- ❑ Multilingual OSD user controls
- ❑ VESA DPMS power saving
- ❑ Built-in speakers for multimedia application
- ❑ Resistive type touch screen
- ❑ Kensington lock capability

## Package Overview

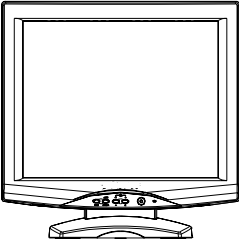

LCD Display

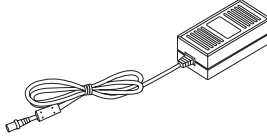

Power Adapter

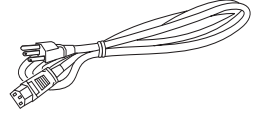

Power Cord

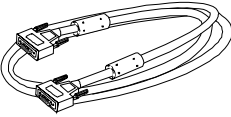

VGA Signal Cable

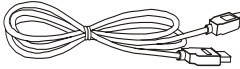

USB Cable  
(for Touch screen)



Audio-In Cable

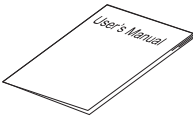

User's Manual

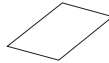

Quick Start Guide

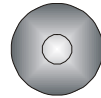

Family Product CD

**Notice:** One end of the VGA Signal cable already connected to the LCD display.

# *Installation*

## Product Overview

### ◆ Front View

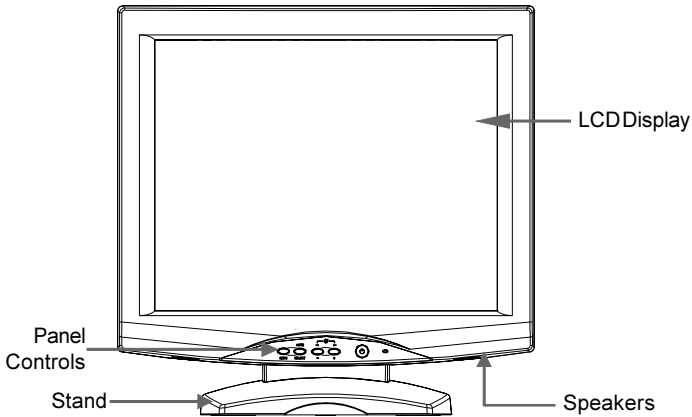

### ◆ Rear View

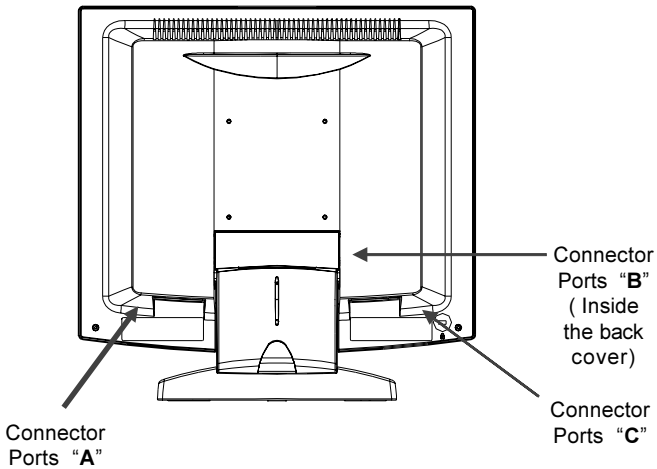

◆ **Connector Port “A”**

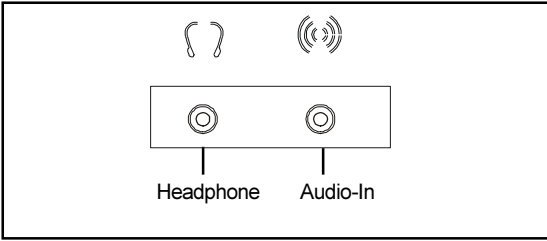

◆ **Connector Ports “B”**

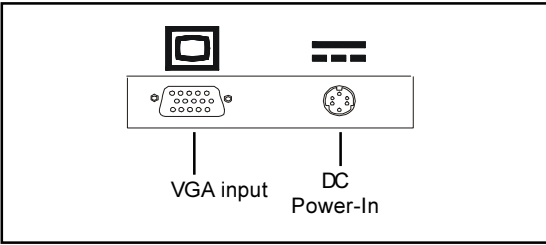

◆ **Connector Ports “C”**

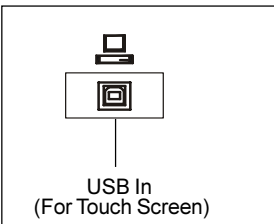

**Touch Function**

## ◆ Remove the Back Cover

Please follow the instruction to remove the cover on the back panel of the LCD so that you can connect the cables in "Connector Ports B."

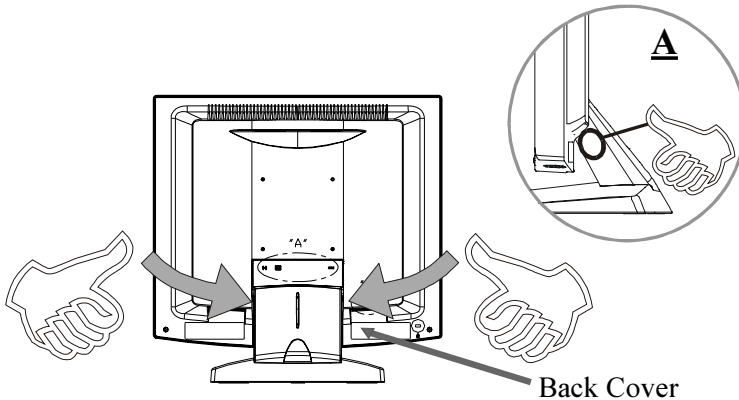

1. To remove the back cover, follow the arrows in Figure A and press with both your thumbs. The cover should be easily removed by pressing firmly.
2. Follow the instruction on P.9 (Figure 9.1) to connect the cables in "Connector Ports B."
3. Fix the cover back to the LCD. You may also keep the cables in order with the cable organizer.

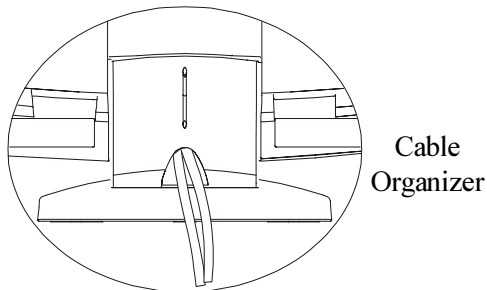

*Note: You can place the LCD horizontally to make it easier to connect the cables. Please make sure that you place it on an even surface lest the LCD should be damaged by scratches or collision.*



## Start Your Installation

### ◆ Connecting the Display (Figure 9.1)

To setup this display, please refer to the following figure and procedures.

1. Be sure all equipment are off.
2. Connect the DC power cord to the power connector (The arrow sign ↑ must face down); plug one end of the AC power cord into the power adapter, and then the other end into an electrical outlet(❶).
3. For the PC with Analog output: Connect the VGA signal cable from display VGA input connector to the 15-pin connector of your host computer and tighten the screws(❷).
4. Connect the Audio-In cable from audio input port of your display to the Audio-out port of your computer(❸).
5. Connect your headphone to Headphone port(❹).
6. Connect the USB cable from USB input port of your display to the USB port of your computer(❺).
7. Turn on your computer, display and video source.

**Notice:** *To ensure the LCD display can work well with your computer, please configure the display mode of your graphic card to make it less than or equal to 1280 x 1024 resolution and make sure timing of the display mode is compatible with the LCD display. We have listed the “Compatibility Modes” of this LCD display in appendices for your reference.*

Figure 9.1

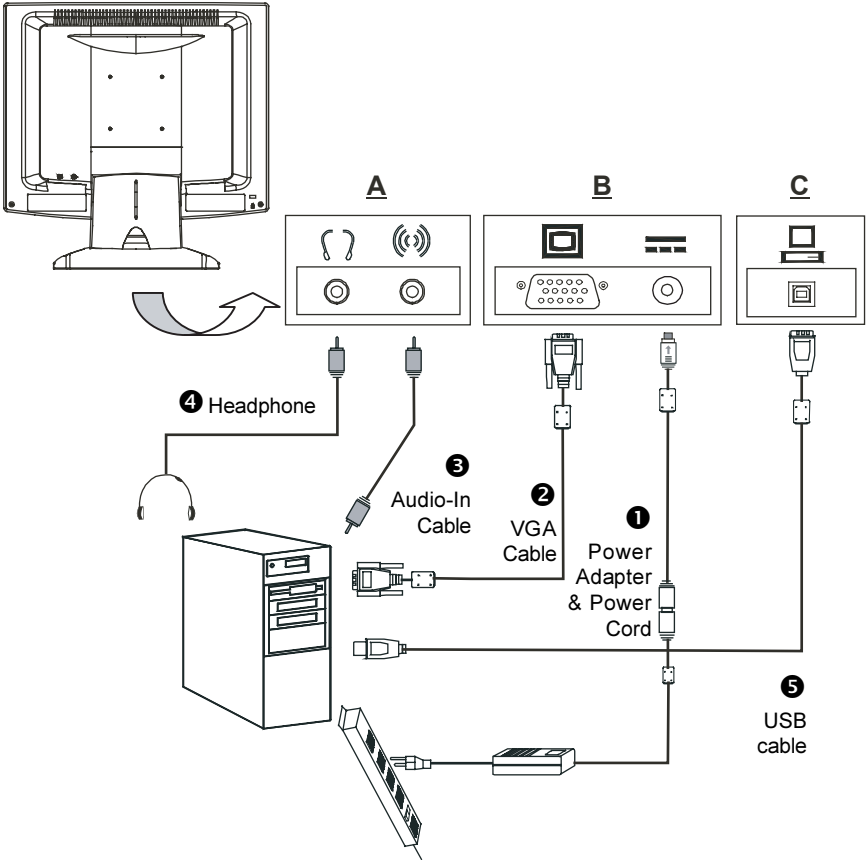

# User Controls

## Front Panel Controls

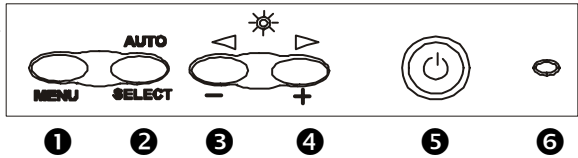
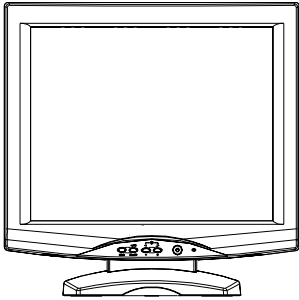

No./ Icon	Control	Function
① MENU	Menu button	To pop up the OSD menus.
② SELECT/AUTO	Select/Auto	<i>Select</i> - To select the adjustment items from OSD menus. <i>Auto</i> - To activate the "Auto Adjustment" function to obtain an optimum image.
③ ◀	Brightness Minus/Minus	1. Decreases the brightness of the display image. 2. Decreases value of the adjustment items.
④ ▶	Brightness Plus/Plus	1. Increases the brightness of the display image. 2. Increases value of the adjustment items.
⑤ ⏻	Power Switch	Switches on/off the power of the LCD display.
⑥	Power LED	1. Green indicates the display is turned on. 2. Amber indicates the display in power-saving mode.

---

## How to Use the OSD Menu

1. Press the “Menu” button to pop up the on-screen menu and to select between the four Main Menus.
2. Choose the adjustment items by pressing the “Select/Auto” button.
3. Adjust the value of the adjustment items by pressing the “◀” or “▶” button.
4. Once you don’t operate the OSD menus after a pre-set time, the OSD menus will automatically disappear.

## On-Screen Display Menus

*First OSD Menu:*

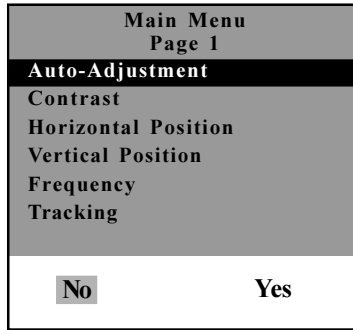

▶ ***Auto-Adjustment***

Choose this function to obtain an optimum image.

▶ ***Contrast***

Adjusts the contrast of the display image.

▶ ***Horizontal Position***

Changes the horizontal position of the image.

▶ ***Vertical Position***

Changes the vertical position of the image.

▶ ***Frequency***

Changes the display data frequency to match the frequency of your graphic card. When you are experiencing vertical flickering bar, use this function to make an adjustment.

▶ ***Tracking***

Synchronizes the signal timing of the display to that of the graphic card. When you are experiencing unstable or flickering image, use this function to make an adjustment.

*Second OSD Menu:*

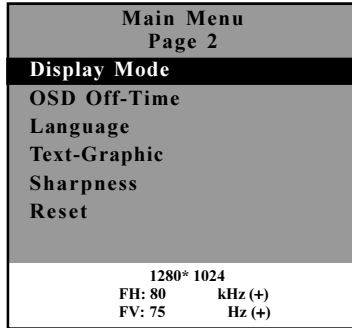

▶ **Display Mode**

Selects this function to demonstrate the display resolution, vertical refresh, and horizontal scan of the current mode.

▶ **OSD Off-Time**

Adjusts the time period for OSD menu to disappear.

▶ **Language**

Chooses the language you need.

▶ **Text-Graphic**

Toggles between VGA text mode (mode M03H) and graphic mode (mode M13H).

▶ **Sharpness**

Adjust the sharpness of the image.

▶ **Reset**

Returns the display parameters of the current mode to its factory default settings.

*Third OSD Menu:*

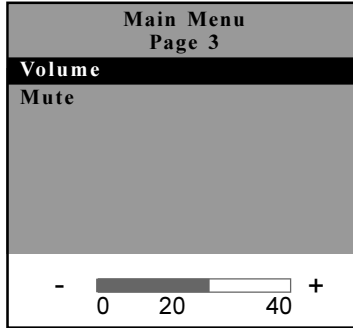

▶ **Volume**

It allows you to control the volume sound.

▶ **Mute**

It allows you to disable the sound immediately.

*Fourth OSD Menu:*

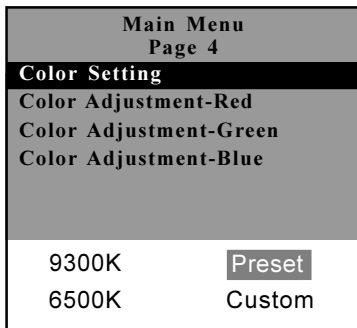

- ▶ ***Color Setting***  
Adjusts the color temperature.
- ▶ ***Color Adjustment-Red***  
It allows you to adjust the red color of the display.
- ▶ ***Color Adjustment-Green***  
It allows you to adjust the green color of the display.
- ▶ ***Color Adjustment-Blue***  
It allows you to adjust the blue color of the display.



# Appendix

## Troubleshooting

*If you are experiencing trouble with the LCD display, refer to the following. If the problem persists, please contact your local dealer or our service center.*

### ***Problem: No image appears on screen.***

- ▶ Check that all the I/O and power connectors are correctly and well connected as described in the “Installation” section.
- ▶ Make sure the pins of the connectors are not crooked or broken.

### ***Problem: Partial image or incorrectly displayed image.***

- ▶ Check to see if the resolution of your computer is higher than that of the LCD display.
- ▶ Reconfigure the resolution of your computer to make it less than or equal to 1280 x 1024.

### ***Problem: Image has flickering vertical line bars.***

- ▶ Use “Frequency” to make an adjustment.
- ▶ Check and reconfigure the display mode of the vertical refresh rate of your graphic card to make it compatible with the LCD display.

### ***Problem: Image is unstable and flickering***

- ▶ Use “Tracking” to make an adjustment.

### ***Problem: Image is scrolling***

- ▶ Check and make sure the VGA signal cable (or adapter) is well connected.
- ▶ Check and reconfigure the display mode of the vertical refresh rate of your graphic card to make it compatible with the LCD display.

### ***Problem: Vague image (characters and graphics)***

- ▶ Use “Frequency” to make an adjustment. If this problem still exists, use “Tracking” to make an adjustment.

## Warning Signal

*Sometimes you probably will see the warning messages from this LCD screen. This means that the LCD display cannot exactly receive the signal from the computer graphic card.*

*There are three kinds of situations that may happen. Please check the cable connections or contact your local dealer for more information.*

### ▶ **No Signal**

This message means that the LCD display has been powered on but it cannot receive any signal from the computer graphic card. Check all the power switches, power cables, and VGA signal cable.

### ▶ **Going to Sleep**

This message means that the LCD display is under the power saving mode. In addition, the LCD display will go to this sleeping mode when experiencing a sudden signal disconnecting problem.

### ▶ **Unsupport Mode**

This message means that the signal of the computer graphic card is not compatible with the LCD display. When the signal is not included in the compatibility mode we have listed in the Appendices of this manual, the LCD display will appear this message.

## Product Dimensions

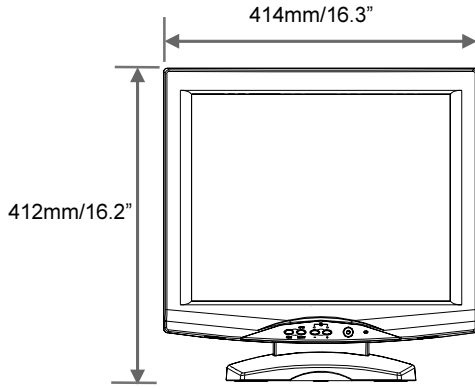

Front View

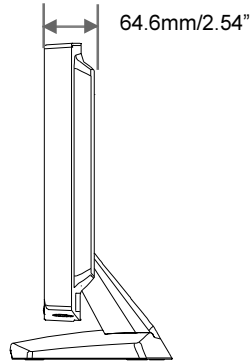

Side View

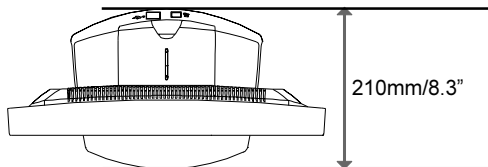

Top View

## Compatibility Modes

IBM VGA	640 x 350	70	31.5
IBM VGA	640 x 400	70	31.5
IBM VGA	640 x 480	60	31.5
IBM VGA	720 x 400	70	31.5
VESA VGA	640 x 480	72	37.9
VESA VGA	640 x 480	75	37.5
VESA SVGA	800 x 600	56	35.2
VESA SVGA	800 x 600	60	37.9
VESA SVGA	800 x 600	72	48.1
VESA SVGA	800 x 600	75	46.9
VESA XGA	1024 x 768	60	48.4
VESA XGA	1024 x 768	70	56.5
VESA XGA	1024 x 768	75	60.0
VESA SXGA	1280 x 1024	60	64
VESA SXGA	1280 x 1024	75	80
Apple Mac LC	640 x 480	67	34.9
Apple Mac II	640 x 480	67	35.0
Apple Mac	832 x 624	75	49.7
Apple Mac	1024 x 768	75	60.2

# Touch Screen Driver Installation

Follows are the procedures for touch screen driver setting up.

## **Windows Environment**

1. Insert the CD-ROM in your computer's CD-ROM drive.
2. Follow the directions on screen to complete the driver setup for your version of Windows.
  - \* If the AutoStart feature is not active:
    1. Click Start > Run
    2. Click the **Browse** button to locate the "**touch.exe**" program on the CD-ROM.
    3. Click **Open**, then **OK** to run the "**touch.exe**".
    4. Follow the directions on screen to complete the driver setup for your version of Windows.

## **DOS Environment**

1. Insert the CD-ROM in your computer's CD-ROM drive.
2. From DOS, type d:\EloDW to change to the correct directory on the CD-ROM ( your CD-ROM drive may be mapped to a different driver letter).
2. Type "**Install**" and press "**Enter**" to start the installation.
3. Align the touch screen.

## Planar Systems, Inc.

Customer Service

**Online Support:** <http://planar.custhelp.com>

**E-mail:** [desktopmonitors@planar.com](mailto:desktopmonitors@planar.com)

**Tel:** 1-866-PLANAR-1 (1-866-752-6271)

**Hours:** M-F, 8am - 9pm Eastern Time

©3/2003 **Planar Systems, Inc.** 03/03 Planar is a registered trademark of Planar Systems, Inc.  
Other brands and names are the property of their respective owners.  
Technical information in this document is subject to change without notice.